

Connection diagram

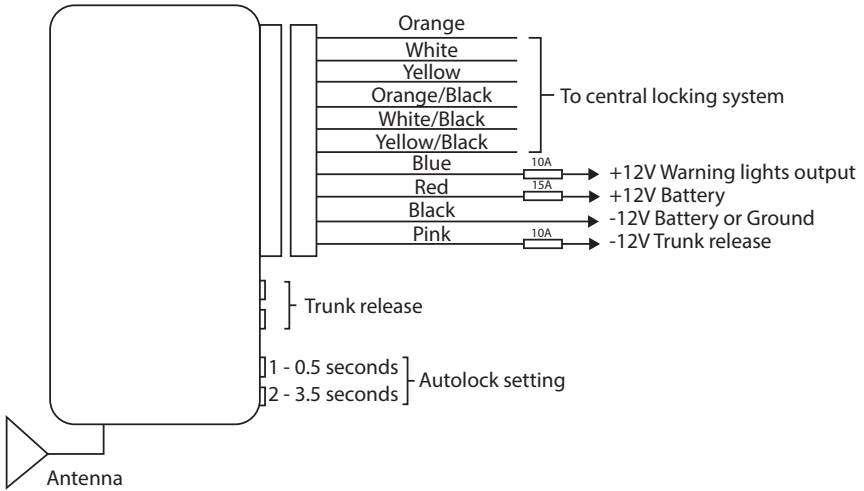

Operating modes



F1: Alarm output

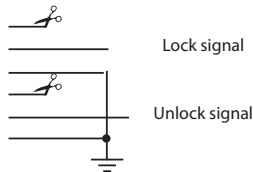

F2: Negative trigger

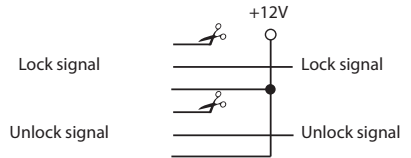

F3: Positive trigger

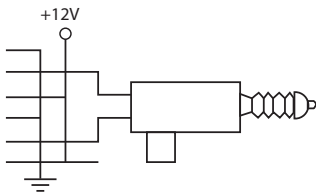

F4: Positive/Negative trigger

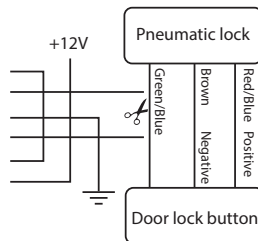

F5: Pneumatic lock

Diagrama conexiuni

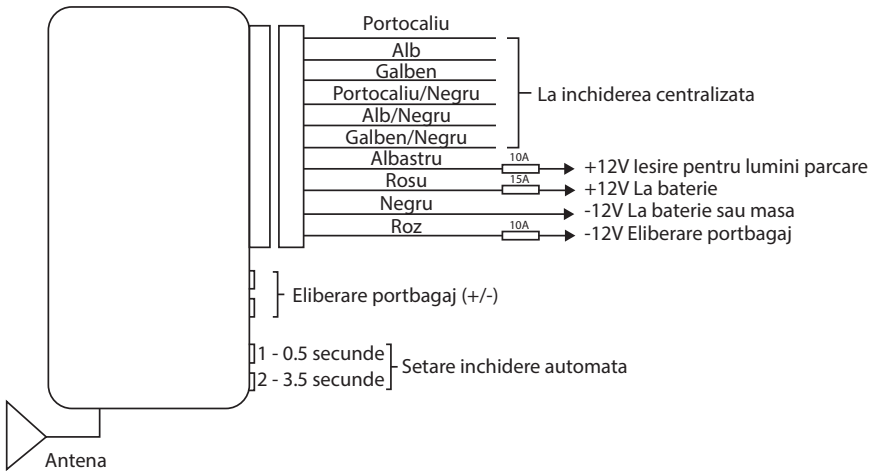

Moduri functionare

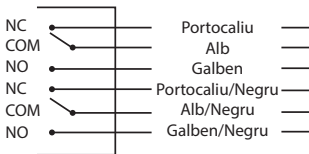

F1: lesire alarma auto

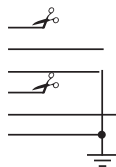

F2: Declansare pe front negativ

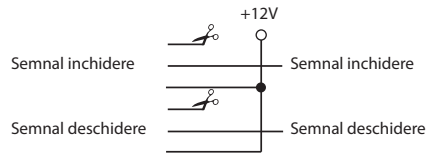

F3: Declansare pe front pozitiv

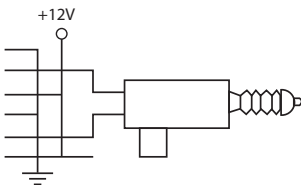

F4: Declansare pe front pozitiv/negativ

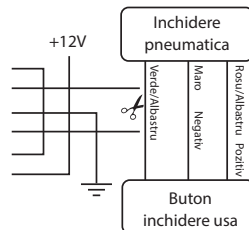

F5: Inchidere pneumatica