



----- **PNI GreenHouse SP6000** -----

**6KW MPPT**

User manual ... page 1  
Manual de utilizare ... pagina 27

# 1. Notes on this manual

## 1.1 Validity and information

This manual describe the assembly, installation, commissioning and maintenance of the following SP Series inverter model: SP3600、SP4200、SP4600、SP5000、SP6000. The manual and other documents must be stored in a convenient place and be available at all times. For possible changes in this manual, we accept no responsibilities to inform the users.

## 1.2 Target Group





This manual is for qualified personnel. Qualified personnel have received training and have demonstrated skills and knowledge in the construction and operation of this device. Qualified Personnel are trained to deal with the dangers and hazards involved in installing electric devices.

Any trouble in the installation, you can contact the supplier .









## 1.3 Symbols in this document

### 1.3.1 Warning in this document

A warning describes a hazard to equipment or personnel. It calls attention to a procedure or practice, which, if not correctly performed or adhered to, could result in damage to or destruction of part or all of the SP Series equipment and/or other equipment connected to the SP Series equipment or personal injury.

Symbol	description
	<b>DANGER</b> indicates a hazardous situation which, if not avoided, will result in death or serious injury.
	<b>WARNING</b> indicates a hazardous situation which, if not avoided, could result in death or serious injury.
	<b>CAUTION</b> indicates a hazardous situation which, if not avoided, could result in minor or moderate injury.
	<b>NOTICE</b> is used to address practices not related to personal injury.
	<b>Information</b> that you must read and know to ensure optimal operation of the system.

### 1.3.2 Markings on this product

Symbol	description
	<b>Electrical voltage!</b> Danger of high voltage and electric shock.
	<b>Risk of burns!</b> Danger of hot surface.
	<b>Operation after 5 minutes</b> Signals danger due to electrical shock and indicates the time(5 minutes ) to allow after the inverter has been turned off and disconnected to ensure safety in any installation operation .
	<b>CE mark.</b> The inverter complies with the requirements of the applicable EC guidelines.
	<b>Point of connection for grounding protection</b>
	<b>Direct Current (DC)</b>
	<b>Alternating Current (AC)</b>
	<b>The inverter has no transformer.</b>
	<b>Read the manual</b>

## 1.4 Glossary AC

Abbreviation for "Alternating Current"

## DC

Abbreviation for "Direct Current"

## Energy

Energy is measured in Wh (watt hours), kWh (kilowatt hours) or MWh (megawatt hours). The energy is the accumulation of power over time. for example, your inverter operates at a constant power of 5000 W for half an hour and then at a constant power of 2500 W for another half an hour, it has fed 3750Wh of energy into the power distribution grid within that hour.

Power is measured in W (watts), kW (kilowatts) or MW (megawatts). Power is an instantaneous value. It displays the power your inverter is currently feeding into the power distribution grid.

## Power rate

Power rate is the ratio of current power feeding into the power distribution grid and the maximum power of the inverter that can feed into the power distribution grid.

# Power Factor

Power factor is the ratio of real power and apparent power. They are identical only when current and voltage are in phase and the power factor is 1.0. The power in an ac circuit is very seldom equal to the direct product of the volts and amperes. In order to find the power of a single phase ac circuit the product of volts and amperes must be multiplied by the power factor.

# PV

Abbreviation for photovoltaic

# wireless communication

The external wireless communication technology is a radio technology that allows the inverter and other communication products to communicate with each other. The external wireless communication does not require line of sight between the devices and it is selective purchasing.

## 2. Safety

### 2.1 Intended Use

The unit converts the DC current generated by the photovoltaic (PV) modules to grid-compliant alternating current and performs single-phase feed-in into the electricity Grid. SP3600M, SP4200M, SP4600M, SP5000M, SP6000M inverters are built according to all required safety rules. Nevertheless, improper use may cause lethal hazards for the operator or third parties, or may result in damage to the units and other property.

### Principle of a PV plant with this SPXXXXM single-phase inverter

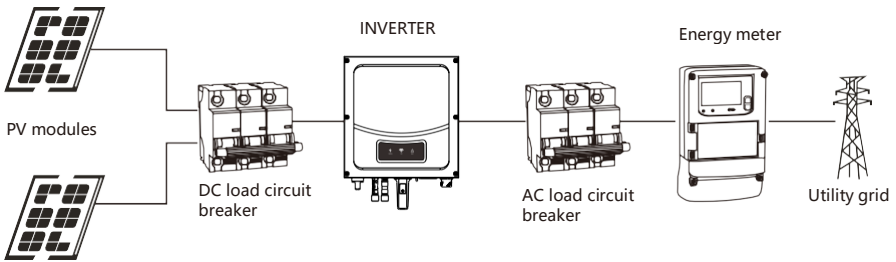

The inverter may only be operated with a permanent connection to the public power grid. The inverter is not intended for mobile use. Any other or additional use is not considered the intended use. The manufacturer/supplier is not liable for damage caused by such unintended use. Damage caused by such unintended use is at the sole risk of the operator.

### PV modules Capacitive Discharge Currents

PV modules with large capacities relative to earth, such as thin-film PV modules with cells on a metallic substrate, may only be used if their coupling capacity does not exceed 470nF. During feed-in operation, a leakage current flows from the cells to earth, the size of which depends on the manner in which the PV modules are installed (e.g. foil on metal roof) and on the weather (rain, snow). This "normal" leakage current may not exceed 50mA due to the fact that the inverter would otherwise automatically disconnect from the electricity grid as a protective measure.



## 2.2 Qualification of skilled person

This grid-tied inverter system operates only when properly connected to the AC -distribution network. Before connecting the SP Series to the power distribution grid, contact the local power distribution grid company. This connection must be made only by qualified technical personnel to connect, and only after receiving appropriate approvals, as required by the local authority having jurisdiction.

## 2.3 Safety instruction



The SP Series Inverters is designed and tested according to international safety requirements; however, certain safety precautions must be observed when installing and operating this inverter. Read and follow all instructions, cautions and warnings in this installation manual. Any questions, please contact the supplier .

## 2.4 Assembly Warnings



 warning	<ul style="list-style-type: none"><li>▶ Before installation, inspect the unit to ensure absence of any transport or handling damage, which could affect insulation integrity or safety clearances; otherwise it could result in safety hazards.</li><li>▶ Assemble each inverter the instructions in this manual. Be Careful when choosing installation location and according to specified cooling requirements. Unauthorized</li><li>▶ remove the necessary protections, improper use, incorrect installation and operation may result the serious safety and shock hazards or equipment damage. In order to minimize the potential of a shock hazard due to hazardous voltages, cover</li><li>▶ the entire solar array with dark material prior to connecting the array to any equipment.</li></ul>
 caution	<ul style="list-style-type: none"><li>▶ Grounding the PV modules:The SP Series is a high frequency inverter(without transformer). That is why it has no galvanic separation. Do not ground the DC circuits of the PV modules when connected to the SP Series. Only ground the mounting frame of the PV modules.If you connect grounded PV modules to the SP Series, that will show error message "PV ISO Low".</li><li>▶ Follow the local requirements for grounding the PV modules and the PV generator. We recommend connecting the generator frame and other electrically conductive surfaces in a manner which ensures continuous conduction with ground in order to have optimal protection of the system and personnel.</li></ul>

## 2.5 Electrical Connection Warnings

 danger	<ul style="list-style-type: none"><li>▶ The components in the inverter are mobilizable. Touching mobilizable components can result in serious injury or death.<ul style="list-style-type: none"><li>● Do not open the inverter except the wire box by qualified persons.</li><li>● Electrical installation, repairs and conversions may only be carried out by electrically qualified persons.</li><li>● Do not touch damaged inverter.</li></ul></li><li>▶ Danger to life due to high voltages in the inverter.<ul style="list-style-type: none"><li>● There has residual voltage in the inverter. The inverter takes 20 minutes to discharge.</li><li>● Wait 20 minutes before you open the wire box. Persons with limited physical or mental abilities may only work with the SP Series</li></ul></li><li>▶ inverter following proper instruction and under constant supervision. Children are forbidden to play with the SP Series inverter. Must keep the SP Series inverter away from children.</li></ul>
--	---

	<ul style="list-style-type: none"> <li>▶ Make all electrical connections (e.g. conductor termination, fuses, PE connection, etc.) in accordance with prevailing regulations. When working with the inverter, adhere to all prevailing safety regulations to minimize risk of accidents. Systems with inverters typically require additional control (e.g., switches, disconnects) or protective devices (e.g., fusing circuit breakers) depending on the prevailing safety rules.</li> </ul>				
	<ul style="list-style-type: none"> <li>▶ The SP Series Inverter converts DC Current from PV generator into AC current. The inverter is suitable for mounting indoors and outdoors.</li> <li>▶ You can use the AC current generated as follows: <table border="1" data-bbox="160 368 994 659"> <tr> <td data-bbox="160 368 309 584">House grid</td> <td data-bbox="309 368 994 584">Energy flows into the house grid. The consumers connected, for example, household devices or lighting, consume the energy. The energy left over is fed into the public grid. When the SP Series is not generating any energy, e.g., at night, the consumers which are connected are supplied by the public grid. The SP Series does not have its own energy meter. When energy is fed into the public grid, the energy meter spins backwards.</td> </tr> <tr> <td data-bbox="160 584 309 659">Public grid</td> <td data-bbox="309 584 994 659">Energy is fed directly into the public grid. The SP Series is connected to a separate energy meter. The energy produced is connected to a meter from the electric power company.</td> </tr> </table> </li> </ul>	House grid	Energy flows into the house grid. The consumers connected, for example, household devices or lighting, consume the energy. The energy left over is fed into the public grid. When the SP Series is not generating any energy, e.g., at night, the consumers which are connected are supplied by the public grid. The SP Series does not have its own energy meter. When energy is fed into the public grid, the energy meter spins backwards.	Public grid	Energy is fed directly into the public grid. The SP Series is connected to a separate energy meter. The energy produced is connected to a meter from the electric power company.
House grid	Energy flows into the house grid. The consumers connected, for example, household devices or lighting, consume the energy. The energy left over is fed into the public grid. When the SP Series is not generating any energy, e.g., at night, the consumers which are connected are supplied by the public grid. The SP Series does not have its own energy meter. When energy is fed into the public grid, the energy meter spins backwards.				
Public grid	Energy is fed directly into the public grid. The SP Series is connected to a separate energy meter. The energy produced is connected to a meter from the electric power company.				

## 2.6 Operation Warnings

	<ul style="list-style-type: none"> <li>▶ Make sure all covers and doors closed and secure during operation..</li> <li>▶ Although designed meeting all safety requirements, some parts and surfaces of Inverter are still hot during operation. To reduce the risk of injury, do not touch the heat sink at the back of the PV-Inverter or nearby surfaces while Inverter is operating. Incorrect sizing of the PV plant may result in voltages which could destroy the inverter. The inverter display will read the error message "PV-Overvoltage!" <ul style="list-style-type: none"> <li>● Switch the rotary DC Disconnect to the Off position immediately.</li> <li>● Contact installer.</li> <li>●</li> </ul> </li> </ul>
	<ul style="list-style-type: none"> <li>▶ All operations regarding transport, installation and start-up, including maintenance must be operated by qualified, trained personnel and in compliance with all prevailing codes and regulations.</li> <li>▶ Anytime the inverter has been disconnected from the power network, please be much careful as some components can retain charge sufficient to create a shock hazard; to minimize occurrence of such conditions, please comply with all corresponding safety symbols and precautions and present on the unit and in this manual. In particular cases, there may still be interference for the specified application area</li> <li>▶ despite maintaining standardized emission limit values (e.g. when sensitive equipment is located at the setup location or when the setup location is near radio or television receivers). In this case, the operator is obliged to take proper action to rectify the situation. Do not stay closer than 20 cm to the inverter for any time.</li> <li>▶</li> </ul>

### 3. Product description

#### 3.1 SP Series Overview

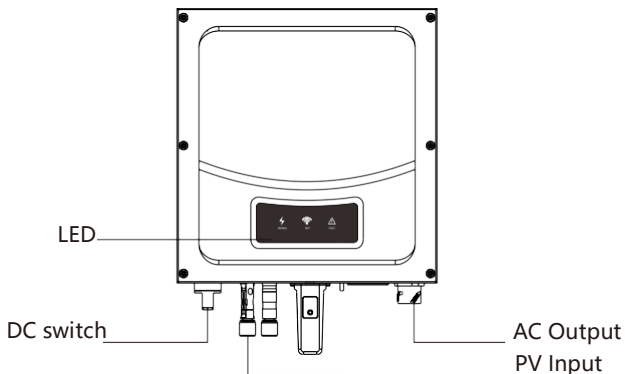

 <b>Information</b>	<p>The SP Series series inverter can choose whether to bring a DC switch depending on customers' need.</p>
---	--







Symbol on the inverter

Symbol	Description	Explanation
	Inverter status symbol	Indicates inverter operation status

#### 3.2 Inverter label

The inverter can be identified by the label on the left side of inverter. It shows the Products type, the inverter specific features and the parameter on the label.

<b>PV Grid Inverter</b>	
Model Name	SP****M
DC max. voltage	***V
MPPT voltage range	**..***V
DC max. current	**A/**A
AC nominal voltage	***V
Grid frequency	50Hz
Rated AC power	****W
Max. AC out apparent power	****VA
Max. AC current	***A
Power factor range	0.95c-0.95i
Protection degree	IP65
Protective class	Class I
Operation ambient temperature	-25°C~+60°C

Please kindly check the inverter detail specifications as below:

Model Name	SP3600	SP4200	SP4600	SP5000	<b>SP6000</b>
Max input DC voltage	550V				
MPPT voltage range	100V-550V				
DC max.current	11A/11A				
AC nominal voltage	230V				
Grid frequency	50HZ				
Rated AC power	3600W	4200W	4600W	5000W	6000W
Max.AC out apparent power	3600VA	4200VA	4600VA	5000VA	6000VA
Max.AC current	16.4A	19.1A	21A	22.8A	27.3A
Communications Ports	USB				
Protective class	Class I				
Protection degree	IP65				
Operation ambient temperature	-25°C-60°C				

### 3.3 Inverter Dimensions

Dimensions and weight:

Model	Height (H)	Width (W)	Depth (D)	Weight
SP6000M	412mm 16.2inch	355mm 14inch	201mm 7.9inch	16kg

### 3.4 Storage environment of Inverter

If you want to storage the inverter in the warehouse, Please select a suitable place to storage. The

- ▶ inverter must be stored in original package and please keep stored in a dry environment The storage
- ▶ temperature should be always between -25°C and +60°C. And the storage relative humidity should be always between 0 and 95%. (Recommend storage environment)
- ▶ If there are a batch of inverters need to be stored, the maximum layers for original carton is four.
- ▶ After long term storage, The local installer or Service centre should perform a comprehensive test before installation the inverter&system;

### 3.5 Advantage of the inverter:

- ▶ Wide input voltage range from 70--550Vdc
- ▶ IP65 protection degree
- ▶ Integrated DC switch
- ▶ DSP controller
- ▶ Fanless integrated cooling technology
- ▶ Multi MPP controller
- ▶ Easy installation



## 4.Installation



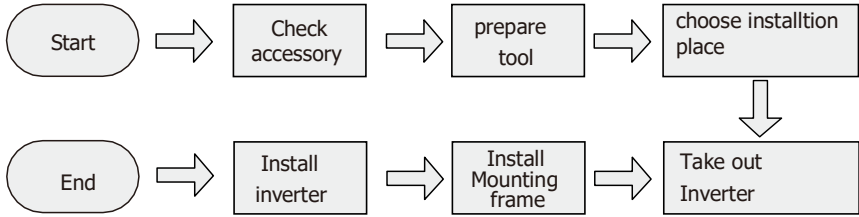



### 4.1 Installation step



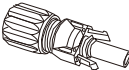
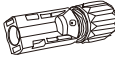

### 4.2 Unpacking and inspection



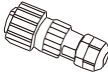

After opening the package, please check the contents of the box. It should contain the following, Please check all of the accessories in carton. If anything missing, please contact your dealer at once.

Shows the components and mechanical parts that should be delivered

NO.	Pictures	description	Quantity
1		SP Series	1PCS
2		Mounting frame	1PCS
3		PV+ input terminal	2PCS
4		PV- input terminal	2PCS
5		Metal terminals secured to PV+ input power cables	2PCS
6		Metal terminals secured to PV- input power cables	2PCS
7		Blasting screws	4PCS
8		M5 cross screws	2PCS

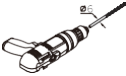
9		Output terminals	1PCS
10		Certificate	1PCS
11		Manual	1PCS

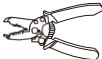
### 4.3 Tools

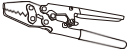
NO.	Tool	Model	Function
1		Hammer drill Recommend drill dia. 6mm	To drill holes on the wall
2		Removal tool	Remove PV terminal
3		Wire stripper	Strip wire
4		Wrench	Turn the screw to connect rear panel with inverter
5		Crimping tools	To crimp power cables

### 4.4 Selecting the installation location

- ▶ This is guidance for installer to choose a suitable installation location, to avoid potential damages to device and operators.
- ▶ The installation location must be suitable for the inverter's weight and dimensions for a long period time.
- ▶ Select the installation location so that the status display can be easily viewed.
- ▶ Do not install the inverter on structures constructed of flammable or thermolabile materials.
- ▶ Never install the inverter in environment of little or no air flow, nor dust environment. That may derate the efficiency of the cooling fan of the inverter.
- ▶ The Ingress Protection rate is IP65 which means the inverter can be installed outdoors and indoors.
- ▶ The humidity of the installation location should be 0~95% without condensation. The installation location must be freely and safely to get at all times.
- ▶ Vertically installation and make sure the connection of inverter must be downwards. Never install horizontal and avoids forward and sideways tilt.

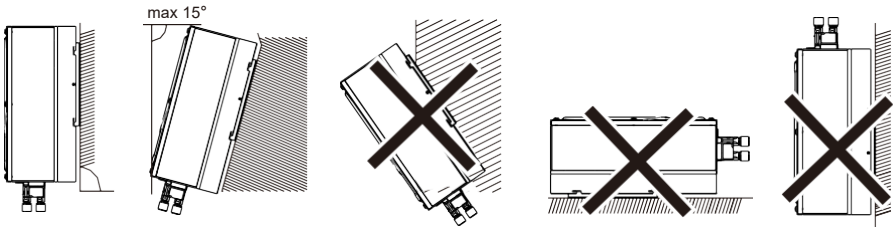

- ▶ Be sure that the inverter is out of the children's reach.
- ▶ Don't put any things on the inverter. Do not cover the inverter.
- ▶ Do not install the inverter near television antenna or any other antennas and antenna cables.
- ▶ Inverter requires adequate cooling space. Providing better ventilation for the inverter to ensure the heat escape adequately. The ambient temperature should be below 40°C to ensure optimum operation.
- ▶ Do not expose the inverter to direct sunlight, as this can cause excessive heating and thus power reduction.
- ▶ Observe the Min. clearances to walls, other inverters, or objects as shown in the diagram:

Direction	Min. clearance (cm)
above	80
below	50
sides	50
front	30

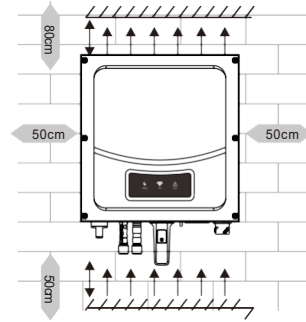

Ambient dimensions of **one inverter**

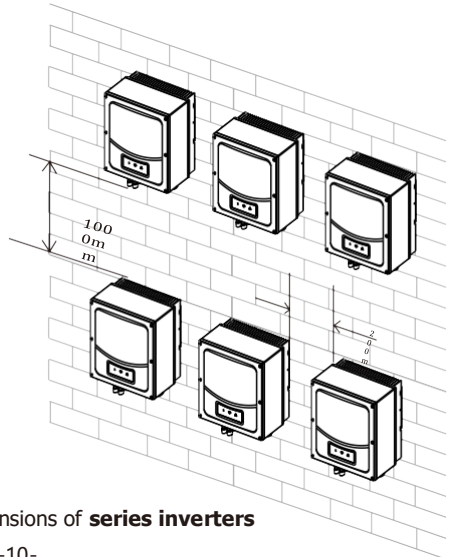
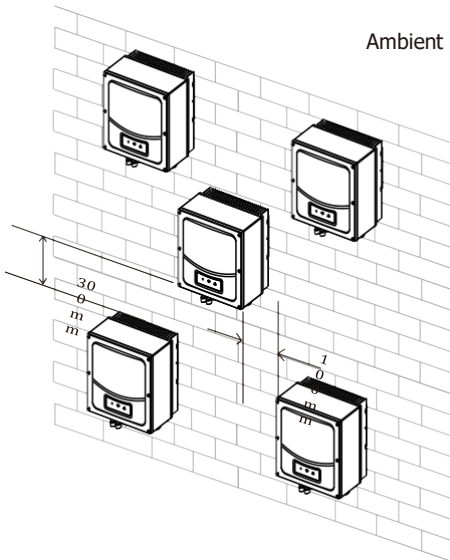

Ambient dimensions of **series inverters**

- ▶ There must be sufficient clearance between the individual inverters to ensure that the cooling air of the adjacent inverter is not taken in.
  - ▶ If necessary, increase the clearance spaces and make sure there is enough fresh air supply to ensure sufficient cooling of the inverters.
- The inverter can't install to solarization, drench, firm location. We suggest that the inverters should be installed at the location with some cover or protection.

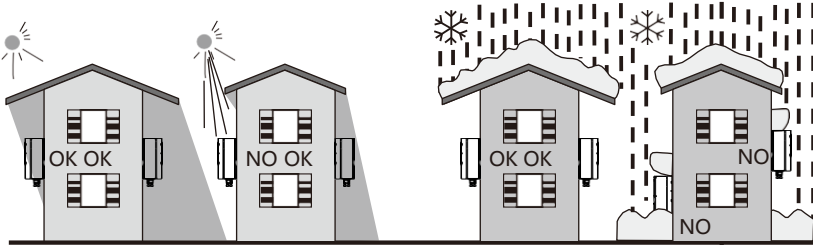

- ▶ Please make sure the inverter is installed at the right place. The inverter can't install close to trunk

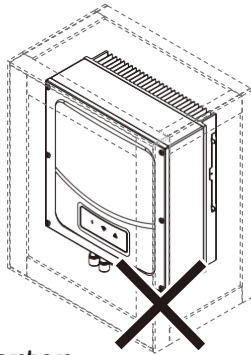

## 4.5 Mounting the Inverter

### 4.5.1 Mounting the Inverter with bracket



In order to avoid electrical shock or other injury, inspect existing electronic or plumbing installations before drilling holes.

- Using the mounting frame as a template, drill 4 holes as illustrated in image.

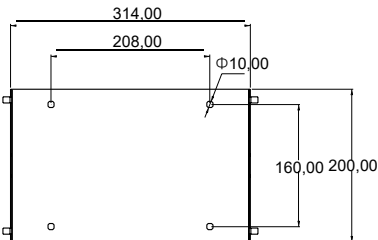

(图a)

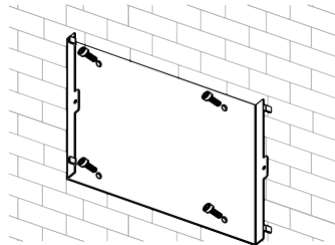

(图b)

## step :

1. Align the mounting frame with hole positions, fix the mounting frame on the wall by tightening the expansion bolt with the nuts.

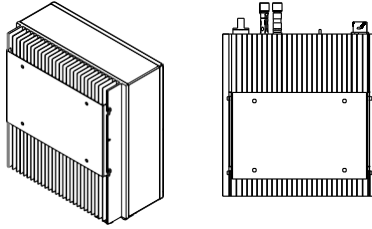

2. Hook the inverter to the rear panel. Using an M5 screw to secure the inverter to the mounting frame to ensure safety.

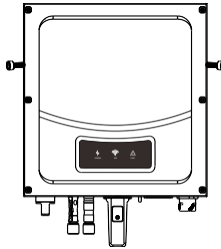

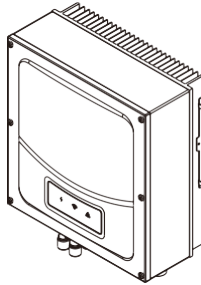

3. make sure all screws install in place.





## 5. Electrical connection

### 5.1 safety

	<p>Danger to life due to lethal voltages! High voltages which may cause electric shocks are present in the conductive parts of the inverter. Prior to performing any work on the inverter, disconnect the inverter on the AC and DC sides</p>
	<p>Danger of damage to electronic components due to electrostatic discharge. Take appropriate ESD precautions when replacing and installing the inverter.</p>

## 5.2 Wiring AC Output

	<p>You must install a separate single-phase circuit-breaker or other load disconnection unit for each inverter in order to ensure that the inverter can be safely disconnected under load.</p> <ul style="list-style-type: none"> <li>● <b>NOTE:</b> The inveter have the residual current detect and protect function, if you have device the AC breaker have the residual current detect function,you must choice breaker the rating residual current more than 300mA.</li> </ul>
	<p>When using inverter with VDE-AR-N 4105, because the inverter's displacement factor adjust function had to accorded to VDE-AR-N 4105,the PV-inverter system total capacity cannot be over 13.8KVA. When using inverter with CEI 0-21: if the inverter system total capacity more than 3KW and up to 11.08KW,the displacement factor is adjustable between 0.95 leading to 0.95 lagging ,and need not the external SPI.if the inverter system total capacity more than 11.08KW,,the displacement factor is adjustable between 0.9leading to 0.9 lagging ,and need the external SPI.</p>

You must install a separate single-phase circuit-breaker or other load disconnection unit for each inverter in order to ensure that the inverter can be safely disconnected under load. We suggest you choice the AC breaker rating current in this table:

SP6000	42A/230V
--------	----------

We recommend electrical connection as below

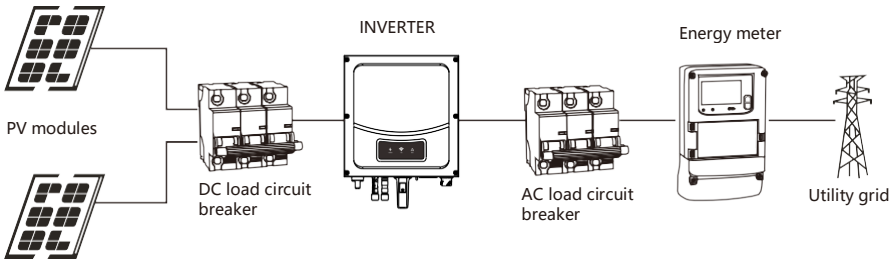

### The AC wiring step

1. The grid connection is contains using 3 conductors (L, N, and PE).

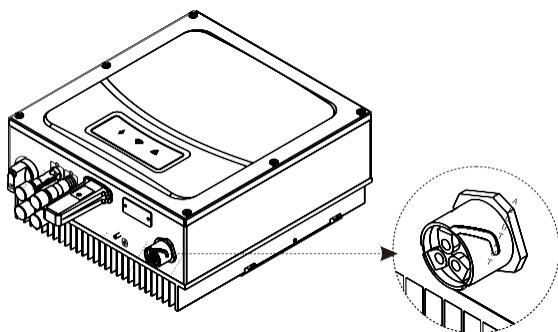

2. Remove the parts of the AC connection plug from the accessory bag. Prepare the pressure screw, sealing ring, threaded sleeve over the AC cable

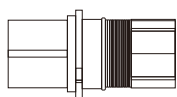

socket element

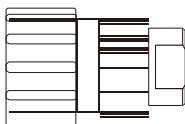

threaded sleeve



sealing ring



pressure screw

3. Insert the stripped and bared conductors L,N,PE into the screw terminals with sign L,N,PE on the socket element and tighten the screws firmly.

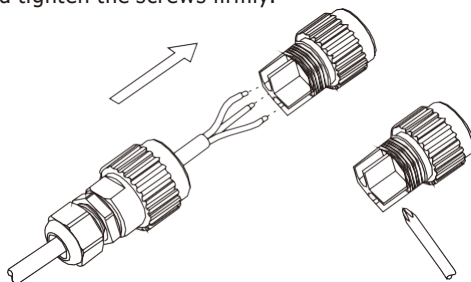

Note that the polarity of the connection line matches the terminal tag to avoid incorrect connection.

4. Push the threaded sleeve into the socket element; screw the pressure screw tightly onto the threaded sleeve;

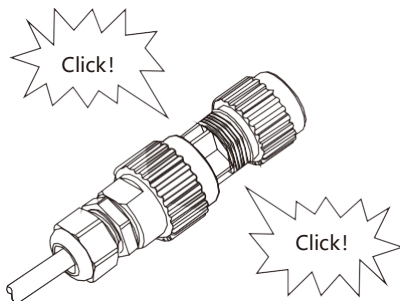

5. Finally, insert the AC connection plug into the AC connection receptacle on the inverter.

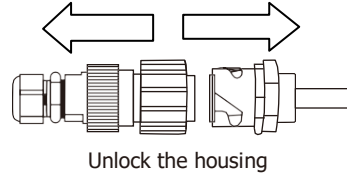
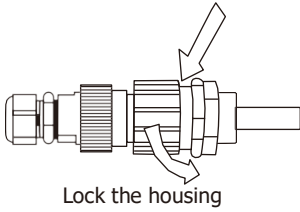

## Wire suggestion length :

Conductor cross section	Max. cable length				
	SP3600	SP4200	SP4600	SP5000	SP6000
5.2mm <sup>2</sup> 10AWG	40m	34m	31m	28m	24m
6.6mm <sup>2</sup> 9AWG	50m	43m	39m	36m	30m

## 5.3 Protect the earth

If the installation is required, the grounding terminal may be used to connect to the secondary protective earthing terminal or as an equipotential connection, as shown in the figure below.

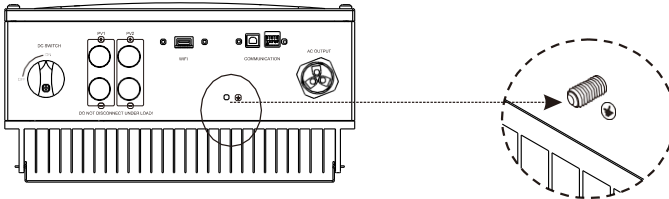

## 5.4 Wiring DC Input

### 5.4.1 Connecting DC Input Power Cables

**Step1** Remove cable glands from the positive and negative connectors.

**Step2** Take out metal terminals from accessory package ,Wiring as illustrated in image.

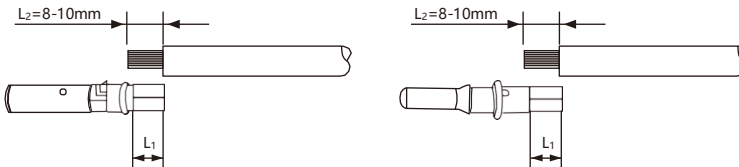

**Step3** Insert the positive and negative power cables into corresponding cable glands.

**Step4** Insert the stripped positive and negative power cables into the positive and negative metal terminals respectively and crimp them using a crimping tool. Ensure that the cables are crimped until they cannot be pulled out by force less than 400 N, as shown in image.



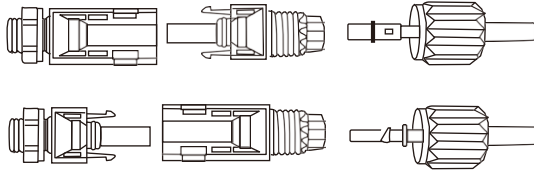

**Step 5** Insert the positive and negative connectors into corresponding DC input terminals of the SP Series until you hear a "click" sound.

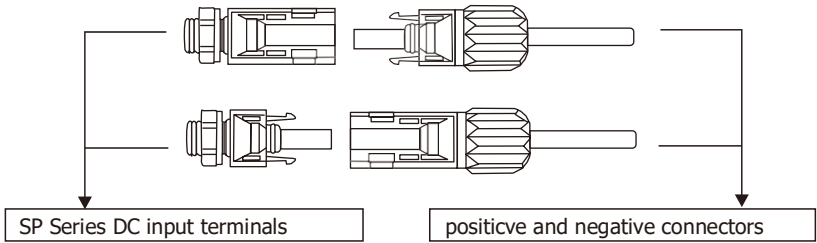

### 5.4.2 Conditions for DC Connection

The SP0 single-phase inverter has 2 independent input : input A & input B

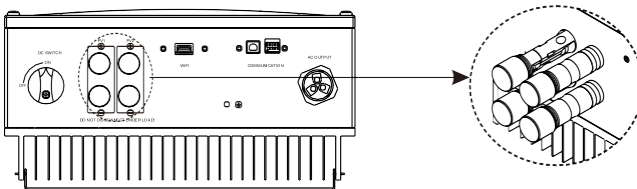

The diagram drawing of DC side is shown as below, notice that the connectors are in paired (male and female connectors). The connectors for PV arrays and inverters are H4 (yunfan) connectors;

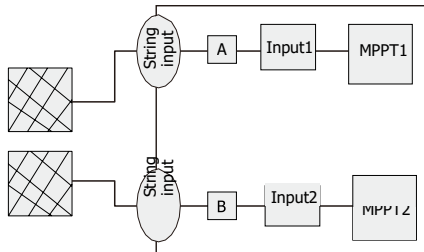

Suggestions for the PV modules of the connected strings:

- ▶ Same type
- ▶ Same quantity of PV modules connected in series



If the inverter is not equipped with a DC switch but this is mandatory in the country of installation, install an external DC switch.  
The following limit values at the DC input of the inverter must not be exceeded:

Model name	Max.current input A	Max.current input B
SP6000M	11A	11A

### 5.4.3 Connecting the PV Array (DC input)

	<p>Before connecting the PV array, ensure that the DC switch and AC breaker are disconnect from the inverter. NEVER connect or disconnect the DC connectors under load.</p> <p>Make sure the maximum open circuit voltage(<math>V_{oc}</math>) of each PV string is less than 550Vdc.</p> <p>Check the design of the PV plant. The Max. open circuit voltage, which can occur at solar panels temperature of <math>-10^{\circ}\text{C}</math>, must not exceed the Max. input voltage of the inverter.</p>
	<p>Improper operation during the wiring process can cause fatal injury to operator or unrecoverable damage to the inverter. Only qualified personnel can perform the wiring work.</p>

### 5.5 Grounding the inverter

The inverter must be connected to the AC grounding conductor of the power distribution grid via the ground terminal (PE) .  $\perp$

	<p>Because of the transformerless design, the DC positive pole and DC negative pole of PV arrays are not permitted to be grounded.</p>
--	--

# 6.Commissioning

## 6.1 LED display

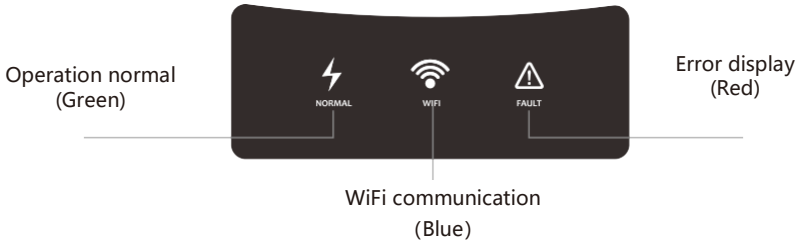

Green LED	Continuous light	Normal status
	Flicker	Waiting status
Blue LED	Flicker	Wifi normal communication
Red LED	Continuous light	Fault status
	Flicker	Program of procedure or give an alarm

## 6.2 WIFI Communication Connection

Please refer to the Wi-Fi Plug14 Quick Installation Guideline.

## 7. Start-Up and shut down the inverter

### 7.1 Start-Up the inverter

1. Connect the AC breaker of the inverter.
2. Turn on the dc switch, and the inverter will start automatically when the input voltage is higher than 100V.

### 7.2 Turn-off the Inverter

	Do not disconnect the DC connectors under load.
---	---

Turn –off the inverter step:

- Disconnect the line circuit breaker from single-phases grid and prevent it from being reactivated.
- Turn off the dc switch.
- Check the inverter operating status.
- Waiting until LED, display have go out, the inverter is shut down.

## 8. Maintenance and Cleaning

### 8.1 Checking Heat Dissipation

If the inverter regularly reduces its output power due to high temperature, please improve the heat dissipation condition. Maybe you need to clean the heat sink.

### 8.2 Cleaning the Inverter

If the inverter is dirty, turn-off the AC breaker and DC switch ,waiting the inverter shut down ,then clean the enclosure lid, the display, and the LEDs using only a wet cloth. Do not use any cleaning agents (e.g. solvents or abrasives).

### 8.3 Checking the DC Disconnect

Check for externally visible damage and discoloration of the DC Disconnect and the cables at regular intervals. If there is any visible damage to the DC Disconnect, or visible discoloration or damage to the cables, contact the installer.

Once a year, turn the rotary switch of the DC Disconnect from the On position to the Off position 5 times in succession. This cleans the contacts of the rotary switch and prolongs the electrical endurance of the DC Disconnect. contacts of the rotary switch and prolongs the electrical endurance of the DC Disconnect.

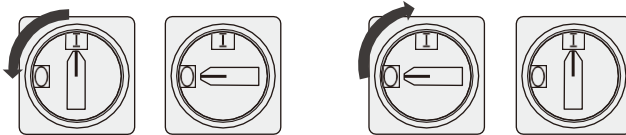

## 9. Trouble shooting

Sometimes, the PV inverter does not work normally, we recommend the following solutions for common troubleshooting. The following table can help the technician to understand the problem and take action.

<b>Error message</b>	<b>Description</b>	<b>Suggestion</b>
NO Utility	No utility grid connected or utility grid power failure.	1. Check AC wiring, especially the ground wire 2. Contact the installation contractor or supplier
Inverter temperature fault	NTC error	1. Restart inverter. 2. If error message still exists, contact the installation contractor or supplier.
PV High fault	The DC input voltage is exceeding the Maximum tolerable value.	1. Disconnect the DC switch immediately.
Grid voltage fault	Utility grid voltage is out of permissible range.	1. Check grid voltage. 2. If the error message still exists despite the grid voltage being within the tolerable range, contact the installation contractor or supplier.
Grid frequency fault	Utility grid Frequency out of permissible range.	1. Check grid frequency. 2. If the error message is displayed despite the grid frequency being within the tolerable range, contact the installation contractor or supplier.
PV ISO fault	Insulation problem	1. Check if panel enclosure ground properly. 2. Check if inverter ground properly. 3. Check if the DC breaker gets wet. 4. If the error message is displayed despite the above checking passed, contact the installation contractor or supplier.
DCI High	Output current DC offset too high	1. Restart inverter. If error message still exists, contact the installation contractor or supplier.
GFCI damage	GFCI Device Damage	1. Restart inverter. 2. If error message still exists, contact the installation contractor or supplier.
Hall sensor fault	HCT fault	1. Restart inverter. 2. If error message still exists, contact the installation contractor or supplier.
Rely fault	Rely error	1. Restart inverter. 2. If error message still exists, contact the installation contractor or supplier.
Communication fault	CPU communication fault	1. Restart inverter. 2. If error message still exists, contact the installation contractor or supplier.
Soft FW fault	Soft FW Don't match	1. Restart inverter. 2. If error message still exists, contact the installation contractor or supplier.
PE fault	No grounding wire or poor contact.	1. check PE If error message still exists, contact the installation contractor or supplier.

Note: If the suggestions do not work, please connect to the the installation contractor or supplier.

## 10. Decommissioning

### 10.1 Dismantling the Inverter

1. Disconnect the inverter as described in section 7.
2. Remove all connection cables from the inverter.



caution

#### **Danger of burn injuries due to hot enclosure parts!**

Wait 20 minutes before disassembling until the housing has cooled down.

3. Screw off all projecting cable glands.
4. Lift the inverter off the bracket and unscrew the bracket screws.

### 10.2 Packing the Inverter

If possible, always pack the inverter in its original carton and secure it with tension belts. If it is no longer available, you can also use an equivalent carton. The box must be capable of being closed completely and made to support both the weight and the size of the inverter.

### 10.3 Storing the Inverter

Store the inverter in a dry place where ambient temperatures are always between -25°C and +60°C.

### 10.4 Disposing of the Inverter



Do not dispose of faulty inverters or accessories together with household waste. Please accordance with the disposal regulations for electronic waste which apply at the installation site at that time. Ensure that the old unit and, where applicable, any accessories are disposed of in a proper manner

## 11. Technical Data

### 11.1 Specifications

Model	SP3600	SP4200	SP4600	SP5000	SP6000
Input data (DC)					
Max. recommended PV power(for module STC)	4100W	4800W	5300W	5750W	7000W
Max.DC voltage	550V				
Start voltage	100V				
PV voltage range	70V-550V				
MPP work voltage rang/nominal voltage	80V-550V				
Full load dc voltage range	173-500V	204-500V	218-500V	238-500V	286-500V
Max.input current per string of tracker A/ tracker B	11A/11A				

Number of independent MPP trackers /strings per MPP tracker	2/1				
DC connection	H4/MC4				
<b>Output (AC)</b>					
Rated AC output power	3600W	4200W	4600W	5000W	6000W
Max.AC apparent power	3600VA	4200VA	4600VA	5000VA	6000VA
Max.output current	16.4A	19.1A	21A	22.8A	27.3A
AC nominal voltage range	220V/230V/240V;180Vac-280Vac				
AC grid frequency range	50±5Hz				
	60±5Hz				
Phase factor at rate power	1				
Displacement power factor, configurable	0.8leading. 0.8lagging				
THDI	< 3%				
AC connection	Single phase				
<b>Efficiency</b>					
Max. efficiency	97.40%				
Euro weighted efficiency	97%				
MPPT efficiency	99.50%				
<b>Protection devices</b>					
Island protection	yes				
Output over current protection	yes				
Output over voltage protection - varistor	yes				
DC reverse polarity protection	yes				
DC switch rating for each MPPT	yes(opt.)				
Ground fault monitoring	yes				
Integrated all-pole sensitive leakage current monitoring unit	yes				
<b>General Data, Features</b>					

Dimensions (W/H/D) in mm	355*412*153	355*412*173	355*412*201
Weight	14kg	15kg	16kg
Operation temperature range	-25°C - +60°C with derating above 45°C		
Noise emission(typical)	≤25dB(A)		
Altitude	2000m(6560ft) without derating		
Self-consumption night	< 1W		
topology	transformerless		
Cooling concept	Natural		
Environmental protection Rating	Ip65		
Relative humidity	95%		
AC connection	connector		
Display	LED		
Interfaces:USB/WI-FI/ Ethernet	yes/yes/opt.		



# 12. PV system installation

Installation with multiple inverters on a single phase system

(A) Single inverter

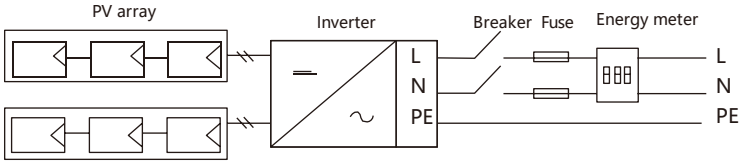

(B) multi inverter

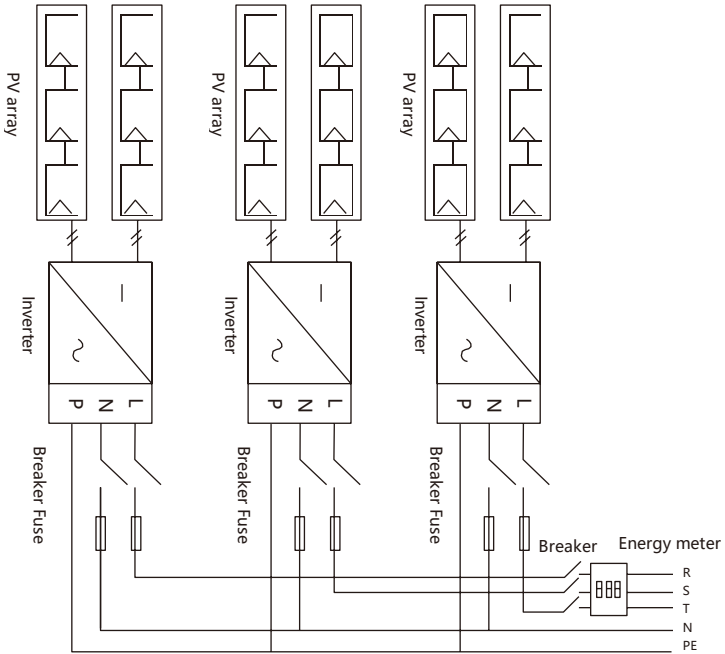

### 13. Data monitoring

Disconnect from WiFi, connect to the internet, access [http://shinemonitor.com/index\\_en.html](http://shinemonitor.com/index_en.html)

#### 13.1 Register and login.

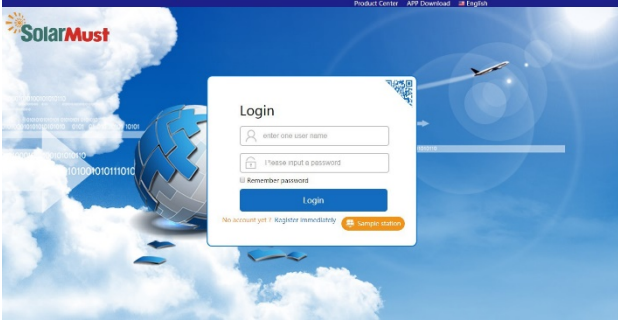

#### 13.2 Create a new power station for the PLANT

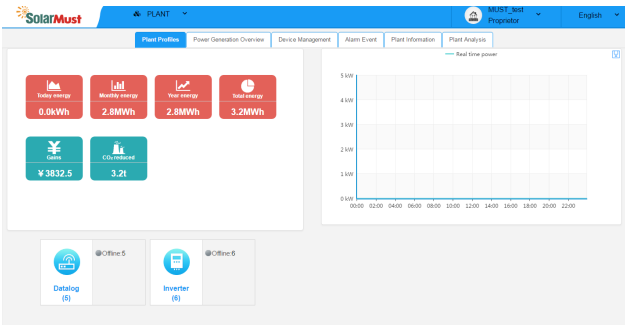

#### 19.3 Click **Add data collector** in **Device management** and add the new WiFi device in PLANT

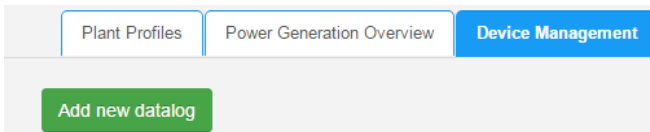

The name of the WiFi device and the inverter will appear on the left side of the page. The inverter screen will be green.

**Add new plant**

1. Install

\* Plant name:

\* Plant installation date:

\* Design power:  kW

Annual planned generation capacity:  kWh

Design companies:

2. Plant location

Country:

Province/State:

City:

Address:

\* Timezone: GMT+08:00 Beijing/Chongqing/Hong Kong/Urumsa/Kuala Lumpur/Singapore

Longitude:  Click 'Open' to select the latitude and longitude page

Latitude:

3. Set income formula (Set 1kwh as the conversion standard)

Default:  Custom:

\* Capital gains: 5.20

Add new datalog

\* Datalog PN:  datalog name:

**Datalogs which belongs to this plant**

Datalog PN	Datalog Name	Datalog Status	Timezone	Firmware	Load Count	Operation/Modify/Restrict/Debug/Delete/Upgrade
X141742003714	X141742003714	Offline	8	1.8.1.0	1	

Add new datalog

\* Datalog PN:  datalog name:

### Simplified EU Declaration of Conformity

SC ONLINESHOP SRL declares that **Solar Inverter ON Grid PNI GreenHouse SP6000** is in accordance with EMC Directive 2014/30/EU and RED Directive 2014/53/EU. The full text of the EU Declaration of Conformity is available at the following internet address: <https://www.mypni.eu/products/6202/download/certifications>

## 1. Note despre acest manual

### 1.1 Valabilitate si alte informatii

Acest manual descrie asamblarea, instalarea, punerea in functiune si intretinerea urmatorului model de invertor din seria SP: SP2500 SP3000. Manualul si alte documente trebuie sa fie depozitate intr-un loc sigur si sa fie disponibile in orice moment. Pentru eventualele modificari aduse acestui manual, nu ne asumam responsabilitatea de a informa in prealabil utilizatorii.

### 1.1 Grup tinta





Acest manual este destinat personalului calificat care a primit instruire si a demonstrat abilitati si cunostinte despre constructia si operarea acestui dispozitiv. Personalul calificat este instruit pentru a face fata pericolelor implicate in instalarea dispozitivelor electrice.

Pentru orice problema in timpul instalarii, contactati furnizorul.









### 1.2 Simboluri din acest manual

#### 1.2.1 Avertizari din acest manual

Un avertisment descrie un pericol pentru echipament sau personal. Atrage atentia asupra unei proceduri sau practici care, daca nu sunt executate sau respectate corect, ar putea duce la deteriorarea sau distrugerea unei parti sau a intregului echipament din seria SP si/sau a altor echipamente conectate la echipamentul din seria SP sau vatamari corporale.

Simbol	Descriere
	<b>PERICOL</b> indica o situatie periculoasa care, daca nu este evitata, va duce la moarte sau vatamari grave.
	<b>AVERTISMENT</b> indica o situatie periculoasa care, daca nu este evitata, poate duce la moarte sau vatamari grave.
	<b>ATENTIE</b> indica o situatie periculoasa care, daca nu este evitata, poate duce la vatamari minore sau moderate.
	<b>NOTIFICARE</b> este folosita pentru a aborda practicile care nu sunt legate de vatamarea corporala.
	<b>Informatii</b> pe care trebuie sa le cititi si sa le cunoasteti pentru a asigura functionarea optima a sistemului.

### 1.2.2 Marcaje pe produs

Simbol	Descriere
	<b>Tensiune electrica!</b> Pericol de inalta tensiune si soc electric.
	<b>Risc de arsura!</b> Pericol de suprafata fierbinte.
	<b>Functionare dupa 5 minute</b> Semneaza pericol din cauza socului electric si indica timpul (5 minute) de care trebuie sa fie acordat dupa ce invertorul a fost oprit si deconectat pentru a asigura siguranta in orice operatiune de instalare.
	<b>Marcaj CE.</b> Invertorul respecta cerintele directivelor CE aplicabile.
	<b>Punct de conectare pentru protectia prin impamintare</b>
	<b>Curent continuu (DC)</b>
	<b>Curent alternativ (AC)</b>
	<b>Invertorul nu are transformator.</b>
	<b>Cititi manualul</b>

### 1.3 Glosar

#### AC

Abreviere pentru "Alternating Current" (curent alternativ)

#### DC

Abreviere pentru "Direct Current" (curent continuu)

#### Energie

Energia se masoara in Wh (watt ora), kWh (kilowatt ora) sau MWh (megawat ora). Energia este acumularea de putere in timp. De exemplu, invertorul dumneavoastra functioneaza la o putere constanta de 5000 W timp de o jumatate de ora si apoi la o putere constanta de 2500 W timp de inca o jumatate de ora, a alimentat 3750 Wh de energie in reseaua de distributie a energiei in acea ora.

#### Putere

Puterea se masoara in W (wati), kW (kilowati) sau MW (megawati). Puterea este o valoare instantanee. Afiseaza puterea pe care invertorul dvs. o alimenteaza in prezent in reseaua de distributie a energiei.

#### Rata de putere

Rata de putere este radioul puterii curente care intra in reseaua de distributie a energiei si puterea maxima a invertorului care poate alimenta reseaua de distributie a energiei..

## Factor de putere

Factorul de putere este raportul dintre puterea reala si puterea aparenta. Ele sunt identice numai atunci cind curentul si tensiunea sunt in faza si factorul de putere este 1,0. Puterea intr-un circuit de curent alternativ este foarte rar egala cu produsul direct al voltilor si amperilor. Pentru a gasi puterea unui circuit de curent alternativ monofazat produsul de volti si amperi trebuie inmultit cu factorul de putere.

## PV

Abreviere pentru fotovoltaic.

## Comunicare Wireless

Tehnologia de comunicare fara fir externa este o tehnologie radio care permite invertorului si altor produse de comunicatie sa comunice intre ele.

## 2. Siguranta

### 2.1 Utilizare

Unitatea converteste curentul continuu generat de modulele fotovoltaice (PV) in curent alternativ conform retelei si efectueaza alimentarea monofazata in reseaua electrica. Invertorul SP6000 este construit conform tuturor regulilor de siguranta cerute.

Cu toate acestea, utilizarea necorespunzatoare poate cauza pericole letale pentru operator sau terti sau poate duce la deteriorarea unitatilor si a altor bunuri.

### Principiul unei instalatii fotovoltaice cu acest invertor monofazat SP6000.

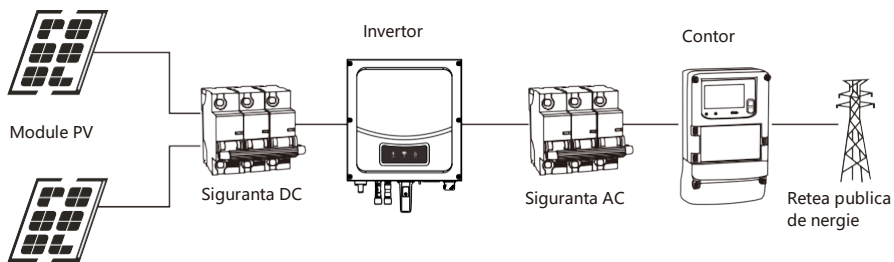

Invertorul poate fi operat numai cu o conexiune permanenta la reseaua publica de energie electrica. Invertorul nu este destinat utilizarii portabile. Orice alta utilizare nu este considerata utilizarea prevazuta. Producatorul/furnizorul nu este responsabil pentru daunele cauzate de o astfel de utilizare neintentionata. Daunele cauzate de o astfel de utilizare neintentionata sunt pe riscul exclusiv al operatorului.

### Curenti capacitivi de descarcare ai modulelor fotovoltaice

Modulele fotovoltaice cu capacitati mari fata de pamint, cum ar fi modulele fotovoltaice cu pelicula subtire cu celule pe un substrat metalic, pot fi utilizate numai daca capacitatea lor de cuplare nu depaseste 470 nF. In timpul operatiunii de alimentare, un curent de scurgere curge de la celule la pamint, a carui dimensiune depinde de modul in care sunt instalate modulele fotovoltaice (de exemplu, folie pe acoperis metalic) si de vreme (ploaie, zapada). Acest curent de scurgere „normal” nu poate depasi 50mA datorita faptului ca, altfel, invertorul s-ar deconecta automat de la reseaua electrica ca masura de protectie.



## 2.2 Personal calificat

Acest invertor grid-tied functioneaza numai atunci cind este conectat corespunzator la reseaua de distributie AC. Inainte de a conecta invertorul la reseaua de distributie a energiei electrice, contactati compania locala de distributie a energiei electrice. Aceasta conexiune trebuie efectuata numai de personal tehnic calificat si numai dupa primirea aprobarilor corespunzatoare, conform cerintelor autoritatii locale.

## 2.3 Instructiuni de siguranta



Invertoarele din seria SP sunt proiectate si testate conform cerintelor internationale de siguranta; totusi, anumite masuri de siguranta trebuie respectate la instalarea si operarea acestui invertor. Cititi si urmati toate instructiunile, precautiile si avertismentele din acest manual de instalare..

## 2.4 Avertismente de asamblare



 warning	<ul style="list-style-type: none"><li>▶ Inainte de instalare, inspectati unitatea pentru a asigura absenta oricaror daune de transport sau manipulare, care ar putea afecta integritatea izolatiei sau distanta de siguranta; altfel ar putea duce la pericole.</li><li>▶ Asamblati fiecare invertor conform instructiunilor din acest manual. Aveti grija cind alegeti locul de instalare si in conformitate cu cerintele de racire specificate.</li><li>▶ Indepartarea neautorizata a protectiilor necesare, utilizarea necorespunzatoare, instalarea si functionarea incorecta pot duce la pericole grave de siguranta si soc electric sau deteriorarea echipamentului.</li><li>▶ Pentru a minimiza potentialul unui pericol de soc electric din cauza tensiunilor periculoase, acoperiti intreaga gama solara cu material inchis la culoare inainte de a conecta reseaua la orice echipament.</li></ul>
 caution	<ul style="list-style-type: none"><li>▶ Impamantarea modulelor fotovoltaice: SP3000 este un invertor de inalta frecventa (fara transformator). De aceea nu are separare galvanica. Nu legati la pamint circuitele DC ale modulelor PV atunci cind sunt conectate la invertor. Impamintati numai cadrul de montare al modulelor fotovoltaice. Daca conectati module fotovoltaice impamintate la invertor, acesta va afisa mesajul de eroare „PV ISO Low”.</li><li>▶ Urmati cerintele locale pentru impamintarea modulelor fotovoltaice si a generatorului fotovoltaic. Recomandam conectarea cadrului generatorului si a altor suprafete conductoare electric intr-o maniera care sa asigure o conducere continua cu pamintul pentru a avea o protectie optima a sistemului si a personalului.</li></ul>

## 2.5 Avertismente privind conexiunea electrica

 danger	<ul style="list-style-type: none"><li>▶ Atingerea componentelor interne invertorului poate duce la vatamari grave<ul style="list-style-type: none"><li>● Nu deschideti invertorul cu exceptia cutiei de cabluri si doar de catre persoane calificate.</li><li>● Instalarea electrica, reparatiile si conversiile pot fi efectuate numai de persoane calificate din punct de vedere electric.</li><li>● Nu atingeti invertorul deteriorat.</li></ul></li><li>▶ Pericol de moarte din cauza tensiunilor ridicate din invertor.<ul style="list-style-type: none"><li>● Exista tensiune reziduala in invertor. Invertorul dureaza 20 de minute pentru a se descarca.</li><li>● Asteptati 20 de minute inainte de a deschide cutia cu conexiunile. Persoanele cu abilitati fizice sau mentale limitate pot lucra cu invertorul din seria SP</li></ul></li><li>▶ numai dupa instructiuni adecvate si sub supraveghere constanta. Copiilor le este interzis sa se joace cu invertorul din seria SP. Trebuie sa pastrati invertorul din seria SP departe de copii.</li></ul>
--	--

 warning	<ul style="list-style-type: none"> <li>▶ Realizati toate conexiunile electrice (de exemplu conductori, sigurante, conexiunea PE etc.) in conformitate cu reglementarile in vigoare. Cind lucrati cu inverterul, respectati toate reglementarile de siguranta in vigoare pentru a minimiza riscul de accidente. Sistemele cu inverteare necesita, de obicei, un control suplimentar (de exemplu, intrerupatoare) sau dispozitive de protectie (de exemplu, intrerupatoare cu siguranta), in functie de regulile de siguranta in vigoare.</li> </ul>				
 caution	<ul style="list-style-type: none"> <li>▶ Inverterul din seria SP transforma curentul continuu de la generatorul fotovoltaic in curent alternativ. Inverterul este potrivit pentru montare in interior si exterior.</li> <li>▶ Puteti utiliza curentul AC generat dupa cum urmeaza:</li> </ul> <table border="1" data-bbox="164 367 1005 670"> <tr> <td data-bbox="164 367 313 582"> Reteaua casnica </td> <td data-bbox="313 367 1005 582"> Energia este trimisa in reseaua casei. Consumatorii conectati, de exemplu, dispozitivele de uz casnic sau iluminatul, consuma energia. Energia ramasa este introdusa in reseaua publica. Cind inverterul nu genereaza energie, de exemplu, noaptea, consumatorii care sunt conectati sunt alimentati de la reseaua publica. Inverterul nu are propriul contor de energie. Cind energia este alimentata in reseaua publica, contorul de energie se roteeste inapoi. </td> </tr> <tr> <td data-bbox="164 582 313 670"> Reteaua publica </td> <td data-bbox="313 582 1005 670"> Energia este trimisa direct in reseaua publica. Inverterul este conectat la un contor de energie separat. Energia produsa este compensata de compania publica de energie electrica. </td> </tr> </table>	Reteaua casnica	Energia este trimisa in reseaua casei. Consumatorii conectati, de exemplu, dispozitivele de uz casnic sau iluminatul, consuma energia. Energia ramasa este introdusa in reseaua publica. Cind inverterul nu genereaza energie, de exemplu, noaptea, consumatorii care sunt conectati sunt alimentati de la reseaua publica. Inverterul nu are propriul contor de energie. Cind energia este alimentata in reseaua publica, contorul de energie se roteeste inapoi.	Reteaua publica	Energia este trimisa direct in reseaua publica. Inverterul este conectat la un contor de energie separat. Energia produsa este compensata de compania publica de energie electrica.
Reteaua casnica	Energia este trimisa in reseaua casei. Consumatorii conectati, de exemplu, dispozitivele de uz casnic sau iluminatul, consuma energia. Energia ramasa este introdusa in reseaua publica. Cind inverterul nu genereaza energie, de exemplu, noaptea, consumatorii care sunt conectati sunt alimentati de la reseaua publica. Inverterul nu are propriul contor de energie. Cind energia este alimentata in reseaua publica, contorul de energie se roteeste inapoi.				
Reteaua publica	Energia este trimisa direct in reseaua publica. Inverterul este conectat la un contor de energie separat. Energia produsa este compensata de compania publica de energie electrica.				

## 2.6 Avertismente de operare

 warning	<ul style="list-style-type: none"> <li>▶ Asigurati-va ca toate capacele si protectiile sunt inchise si securizate in timpul functionarii.</li> <li>▶ Desi sunt concepute pentru a indeplini toate cerintele de siguranta, unele parti si suprafete ale inverterului sunt inca fierbinti in timpul functionarii. Pentru a reduce riscul de ranire, nu atingeti radiatorul din spatele inverterului PV sau suprafetele din apropiere in timp ce inverterul functioneaza.</li> <li>▶ Dimensionarea incorecta a instalatiei fotovoltaice poate duce la tensiuni care ar putea distruge inverterul. Ecranul inverterului va afisa mesajul de eroare „PV-Overvoltage!” <ul style="list-style-type: none"> <li>● Comutati imediat butonul rotativ de deconectare DC in pozitia OFF.</li> <li>● Contactati instalatorul.</li> </ul> </li> </ul>
 caution	<ul style="list-style-type: none"> <li>▶ Toate operatiunile privind transportul, instalarea si punerea in functiune, inclusiv intretinerea, trebuie efectuate de personal calificat, instruit si in conformitate cu toate standardele si reglementarile in vigoare.</li> <li>▶ Ori de cite ori inverterul a fost deconectat de la reseaua de alimentare, va rugam sa fiti foarte atenti, deoarece unele componente pot pastra o incarcare electrica suficienta pentru a crea un soc electric; pentru a minimiza aparitia unor astfel de conditii, va rugam sa respectati toate simbolurile si masurile de siguranta corespunzatoare si prezente pe unitate si in acest manual.</li> <li>▶ In cazuri particulare, pot exista inca interferente pentru zona de aplicare specificata, in ciuda mentinerii valorilor limita de emisie standardizate (de exemplu, atunci cind echipamentele sensibile sunt amplasate la locul de instalare sau cind locatia de instalare este linga receptoare radio sau de televiziune). In acest caz, operatorul este obligat sa ia masurile corespunzatoare pentru a remedia situatia.</li> <li>▶ Nu stati mai aproape de 20 cm de inverter.</li> </ul>



### 3. Descriere produs

#### 3.1 Prezentare invertor

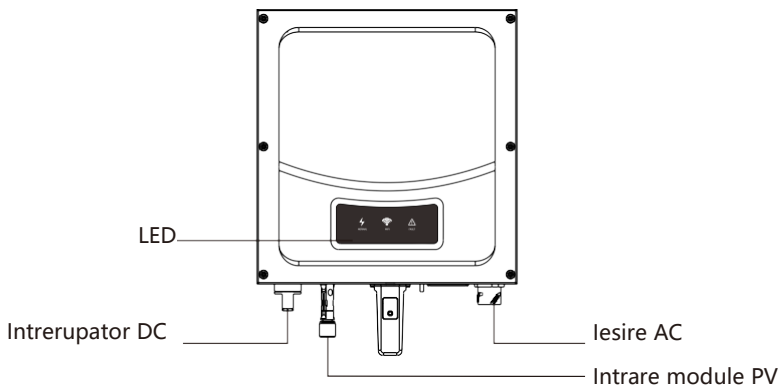

 information	Se poate alege daca este nevoie de un comutator DC conectat la invertor in functie de nevoile clientilor.
--	---

Symbol on the Invertor

Simbol	Descriere	Explicatie
	Stare invertor	Indica statusul de operare al invertorului

#### 3.2 Eticheta invertor

Invertorul poate fi identificat dupa eticheta de pe partea stinga a invertorului. Afiseaza tipul de produs, caracteristicile specifice invertorului si parametrii.

PV Grid Inverter	
Model Name	SP****
DC max. voltage	***V
MPPT voltage range	**_***V
DC max. current	**A
AC nominal voltage	***V
Grid frequency	50Hz
Rated AC power	****W
Max. AC out apparent power	****VA
Max. AC current	***A
Power factor range	0.95c-0.95i
Protection degree	IP65
Protective class	Class I
Operation ambient temperature	-25°C~+60°C



### **Va rugam sa verificati specificatiile detaliate ale invertorului:**

Model	SP6000
Intrare DC max.	550V
Interval tensiune MPPT	100V-550V
Curent DC max	11A/11A
Tensiune nominala AC	230V
Frecventa retea	50Hz
Putere AC nominala	6000W
Putere aparenta AC max.	6000VA
Curent AC max.	27.3A
Port comunicare	USB
Protectie	Clasa I
Clasa	IP65
Temperatura de lucru	-26°C ~ +60°C

### **3.3 Dimensiuni invertor**

Model	Inaltime (H)	Latime (W)	Profunzime (D)	Greutate
SP6000	412mm 16.2inch	355mm 14inch	201mm 7.9inch	16kg

### **3.4 Mediul de depozitare a invertorului**

Daca doriti sa depozitati invertorul, va rugam sa selectati un loc potrivit pentru a-l depozita. Invertorul trebuie depozitat in ambalajul original si va rugam sa-l pastrati intr-un mediu uscat. Temperatura de depozitare trebuie sa fie intotdeauna intre -25°C si +60°C. Umiditatea relativa ar trebui sa fie intotdeauna intre 0 si 95%.

Daca exista un lot de invertoare care trebuie depozitate, numarul maxim de straturi pentru cutia originala este de patru.

Dupa depozitarea pe termen lung, instalatorul sau centrul de service trebuie sa efectueze un test complet inainte de a instala invertorul;

### **3.5 Avantajele invertorului:**

- Interval larg al tensiunii de intrare 70--550Vdc
- Grad de protectie IP65
- Controler DSP
- Comutator DC integrat
- Tehnologie de racire integrata fara ventilator
- Controler Multi MPP
- Instalare usoara





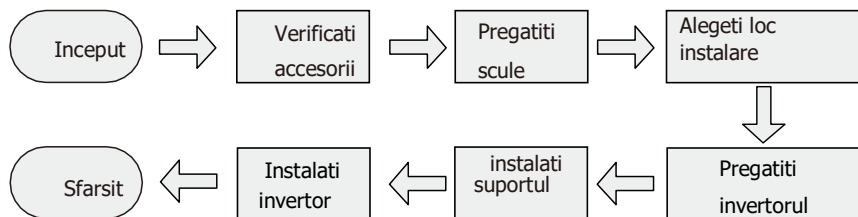

## 4.Instalare

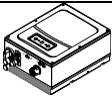

### 4.1 Pasi instalare

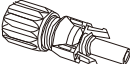
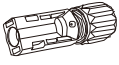



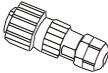

### 4.2 Despachetarea si verificarea

Dupa deschiderea pachetului, va rugam sa verificati continutul cutiei. Ar trebui sa contina urmatoarele. Va rugam sa verificati toate accesoriile din cutie. Daca lipseste ceva, va rugam sa contactati imediat distribuitorul.

NO.	Imagine	Descriere	Cantitate
1		Invertor	1 buc.
2		Suport montaj	1 buc.
3		Terminal intrare PV+	1 buc.
4		Terminal intrare PV-	1 buc.
5		Terminale metalice pentru cablurile de alimentare ale intrarii PV+	1 buc.
6		Terminale metalice pentru cablurile de alimentare ale intrarii PV-	1 buc.
7		Suruburi de sablare	1 buc.
8		Suruburi in cruce M5	2 buc.

9		Terminale de iesire	1PCS
10		Certificat	1PCS
11		Manual	1PCS

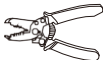
#### 4.3 Scule necesare

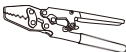
NO.	Scule	Model	Funcție
1		Burghiu cu ciocan Diametrul burghiu 6 mm	Pentru a face gauri in perete
2		Cheie	Indeparteaza modul PV
3		Dispozitiv de dezimbrare	Pentru desizolare cabluri
4		Cheie	Rotiti surubul pentru a conecta panoul din spate cu invertorul
5		Cleste de sertizare	Pentru a sertizat cablurile de alimentare

#### 4.4 Selectarea locatiei de instalare

Acesta este un ghid pentru instalatori pentru a alege o locatie adecvata de instalare, pentru a evita potentialele daune ale dispozitivelor si operatorilor.

Locul de instalare trebuie sa fie adecvat pentru greutatea si dimensiunile invertorului pentru o perioada lunga de timp.

Selectati locatiea de instalare, astfel incit afisarea starii de functionare sa poata fi vizibila cu usurinta.

Nu instalati invertorul pe structuri construite din materiale inflamabile sau termolabile.

Nu instalati niciodata invertorul intr-un mediu cu debit de aer redus sau deloc sau cu praf. Acest lucru poate reduce eficienta ventilatorului de racire.

Gradul de protectie este IP65, ceea ce inseamna ca invertorul poate fi instalat in exterior si in interior.

Umiditatea locului de instalare trebuie sa fie de 0~95% fara condens. Locatia de instalare trebuie sa fie libera si sigura pentru a ajunge in orice moment la invertor.

Instalati invertorul vertical si asigurati-va ca conexiunea invertorului trebuie sa fie in jos. Nu instalati niciodata invertorul orizontal si evitati inclinarea inainte si laterala.

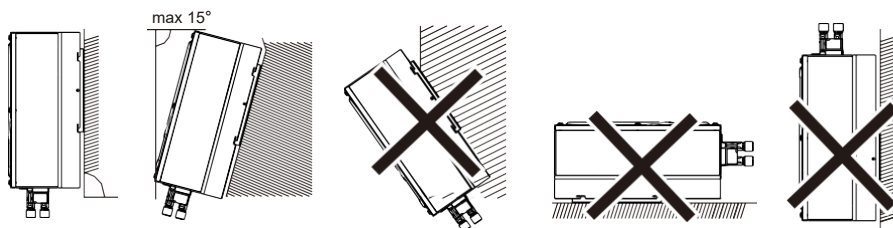

Asigurati-va ca invertorul nu este la indemana copiilor.

Nu puneti nimic pe invertorul. Nu acoperiti invertorul.

Nu instalati invertorul in apropierea antenei de televiziune sau a altor antene si cabluri de antena.

Invertorul necesita spatiu de racire adecvat. Asigurati o ventilatie buna pentru invertorul pentru a asigura evacuarea adecvata a caldurii. Temperatura ambianta trebuie sa fie sub 40°C pentru a asigura o functionare optima.

Nu expuneti invertorul la lumina directa a soarelui, deoarece aceasta poate provoca incalzire excesiva si, prin urmare, reducerea puterii.

Respectati distanta libera fata de pereti, alte invertoare sau obiecte, asa cum se arata in diagrama:

Directie	Spatiu minim (cm)
deasupra	80
dedesubt	50
lateral	50
fata	30

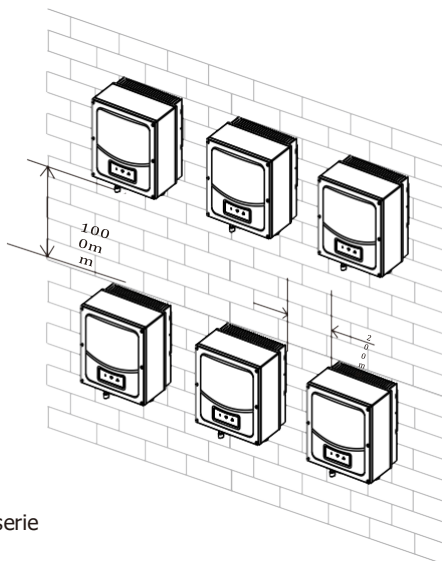
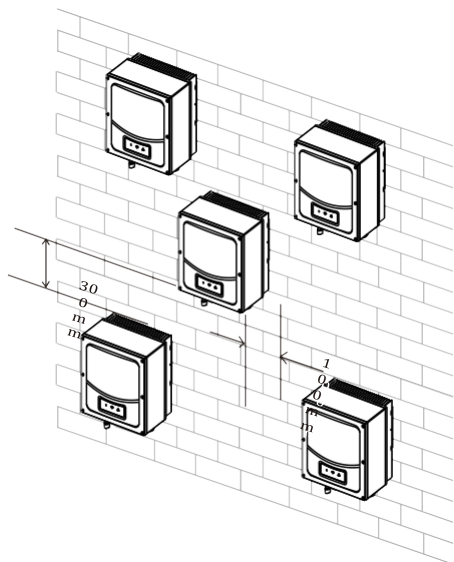
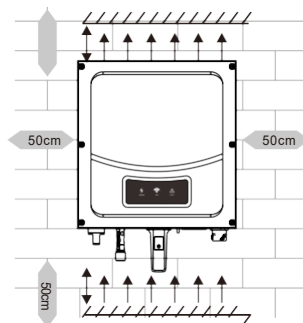

Invertoare in serie

Trebuie sa existe un spatiu suficient intre invertoarele individuale pentru a se asigura ca aerul de racire al invertorului adiacent nu este absorbit.

Daca este necesar, mariti spatiile libere si asigurati-va ca exista suficienta alimentare cu aer proaspat pentru a asigura o racire suficienta a invertoarelor.

Invertorul nu se poate instala la soare sau umezeala. Va sugeram ca invertoarele sa fie instalate in locatii acoperite si protejate de ploaie.

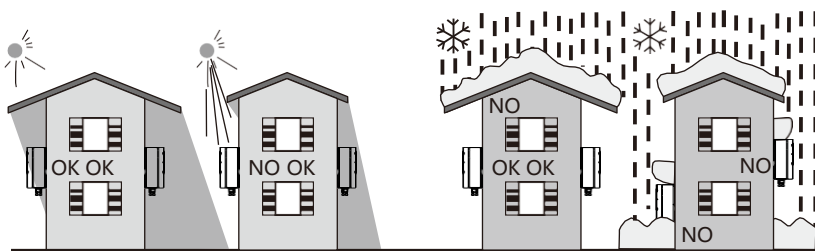

Va rugam sa va asigurati ca invertorul este instalat in locul potrivit. Invertorul nu se poate instala aproape de cutia de protectie.

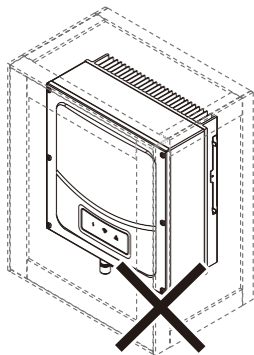

## 4.5 Instalarea invertorului

### 4.5.1 Montarea invertorului cu suport de montaj



Pentru a evita socurile electrice sau alte daune, inspectati instalatiile electrice sau sanitare existente inainte de a face gauri in pereti.

- Folosind cadrul de montare ca sablon, faceti 4 gauri asa cum este ilustrat in imagine.

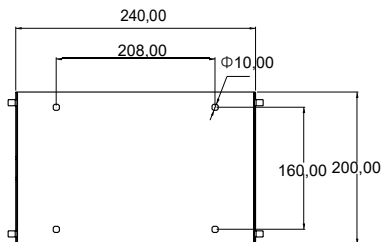

(图a)

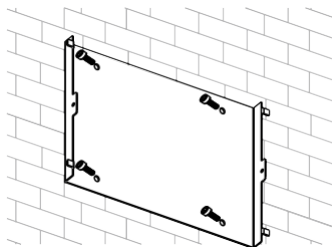

(图b)

### Pasul 1 :

1. Aliniati cadrul de montare cu pozitiile orificiilor, fixati cadrul de montare pe perete stringind surubul de expansiune cu piulitele.

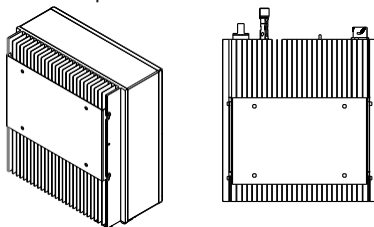

2. Prindeti invertorul de suport. Folosind un surub M5 pentru a fixa invertorul de cadrul de montare.

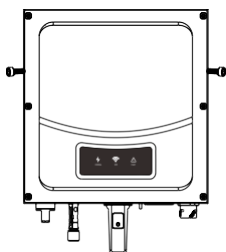

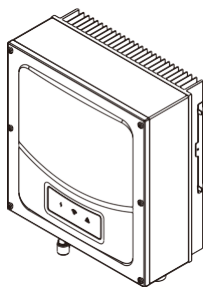

3. Asigurati-va ca suruburile sunt toate fixate bine.





## 5. Conexiuni electrice

### 5.1 Siguranta

	Pericol de moarte din cauza tensiunilor letale! Tensiuni inalte care pot provoca socuri electrice sunt prezente in partile conductoare ale invertorului. Inainte de a efectua orice operatiune la invertor, deconectati invertorul pe partile AC si DC
	Pericol de deteriorare a componentelor electronice din cauza descarcarilor electrostatice. Luati masurile de precautie ESD corespunzatoare atunci cind inlocuiti si instalati invertorul.

## 5.2 Cablare iesire AC

	<p>► Trebuie sa instalati un intrerupator de circuit monofazat separat sau o alta unitate de deconectare a sarcinii pentru fiecare inverter, pentru a va asigura ca inverterul poate fi deconectat in siguranta sub sarcina.</p> <ul style="list-style-type: none"> <li>● <b>NOTA:</b> Inverterul are functia de detectare si protectie a curentului rezidual, daca aveti un dispozitiv, intrerupatorul de curent alternativ are functia de detectare a curentului rezidual, trebuie sa alegeti intrerupatorul cu curent rezidual nominal mai mare de 300mA.</li> </ul>
	<p>► Cind se foloseste un inverter cu VDE-AR-N 4105, deoarece functia de ajustare a factorului de deplasare a inverterului trebuia sa corespunda cu VDE-AR-N 4105, capacitatea totala a sistemului PV-inverter nu poate depasi 13,8KVA. Cind utilizati un inverter cu CEI 0-21: daca capacitatea totala a sistemului inverter este mai mare de 3KW si pina la 11,08KW, factorul de deplasare este reglabil intre 0,95 ducind la 0,95 si nu are nevoie de SPI extern. daca capacitatea totala este mai mare de 11,08 kW, factorul de deplasare este reglabil intre 0,9 ducind la 0,9 intirziere si necesita SPI extern.</p>

Trebuie sa instalati un intrerupator de circuit monofazat separat sau o alta unitate de deconectare a sarcinii pentru fiecare inverter, pentru a va asigura ca inverterul poate fi deconectat in siguranta sub sarcina.

Va sugeram sa alegeti curentul nominal al intrerupatorului AC din acest tabel:

SP6000	42A/230V
--------	----------

Va recomandam conexiunea electrica ca mai jos

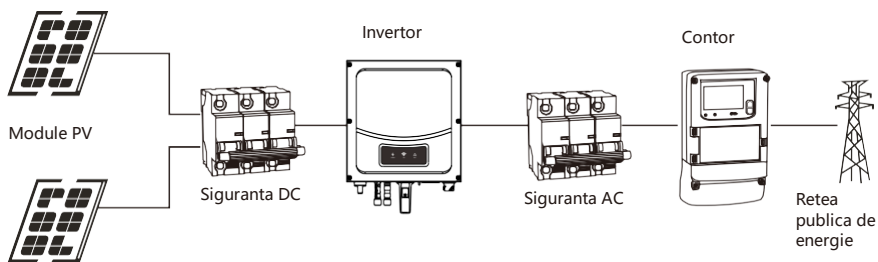

### Conexiunea AC

1. Conexiunea la retea este compusa din 3 conductori (L, N, si PE).



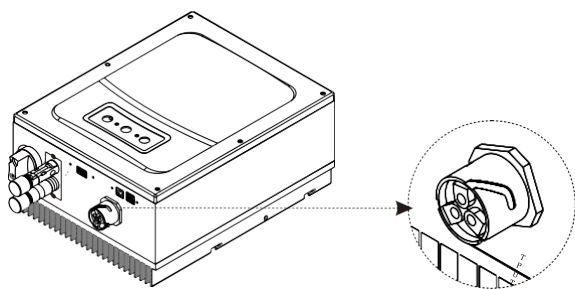

2. Scoateti piesele stecherului de conectare AC din punga de accesorii. Pregatiti surubul de presiune, inelul de etansare, mansonul filetat peste cablul AC

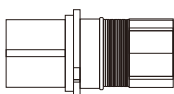

element conexiune

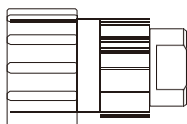

manson filetat



inel de etansare surub de presiune



3. 3. Introduceti conductorii L,N,PE decupati si defundati in bornele suruburilor cu semnul L,N,PE de pe elementul priza si stringeti bine suruburile.

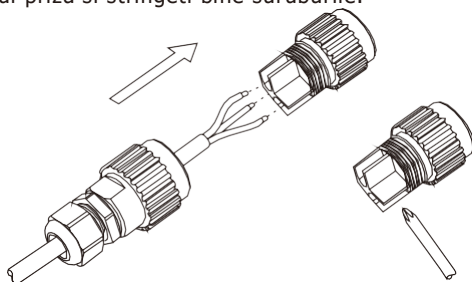

Retineti ca polaritatea liniei de conectare se potriveste cu eticheta terminalului pentru a evita conectarea incorecta.

4. Impingeti mansonul filetat in elementul priza; insurubati strins surubul de presiune pe mansonul filetat;

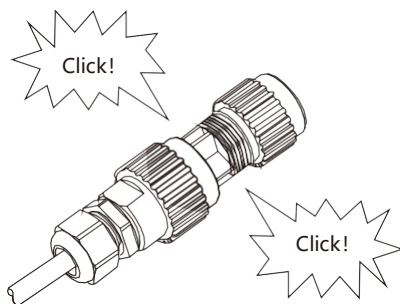

5. In cele din urma, introduceti stecherul de conectare AC in mufa de conectare AC de pe invertor.

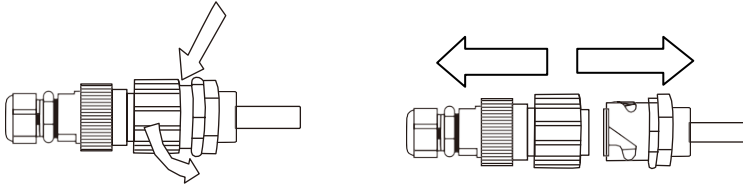

**Lungime recomandata pentru cabluri :**

Sectiune	Lungime maxima
5.2mm <sup>2</sup> 10AWG	24m
6.6mm <sup>2</sup> 9AWG	30m

**5.3 Impamantare**

Daca este necesara instalarea, borna de impamantare poate fi utilizata pentru a conecta la borna de impamantare de protectie secundara sau ca o conexiune echipotentiala, asa cum se arata in figura de mai jos..

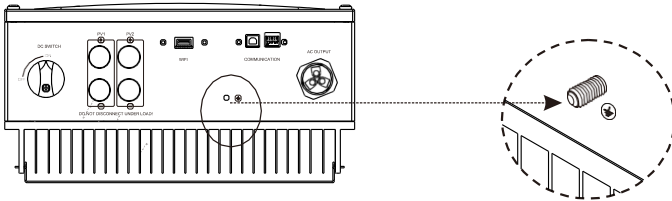

**5.4 Conexiune intrare DC**

**5.4.1 Conectarea cablurilor de alimentare DC**

**Pasul 1** Scoateti presetupele de la conectorii pozitivi si negativi.

**Pasul 2** Scoateti bornele metalice din pachetul de accesorii, conectati asa cum este ilustrat in imagine.

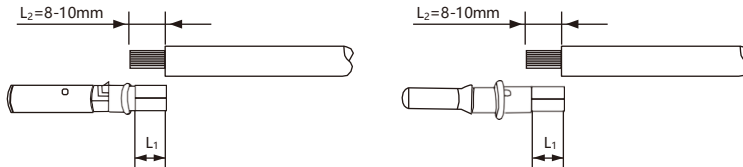

**Pasul 3** Introduceti cablurile de alimentare pozitive si negative in presetupele corespunzatoare.

**Pasul 4** Introduceti cablurile de alimentare pozitive si negative dezlipite in bornele metalice pozitive si, respectiv, negative si sertizeaza-le folosind o unealta de prindere. Asigurati-va ca cablurile sunt sertizate pina cind nu pot fi scoase cu o forta mai mica de 400 N, asa cum se arata in imagine.

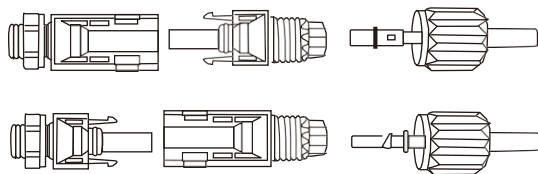

**Pasul 5** Introduceți conectorii pozitivi și negativi în bornele de intrare DC corespunzătoare ale invertorului pînă cînd auziți un "clic".

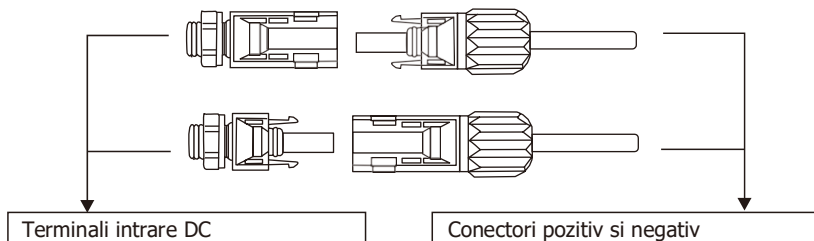

#### 5.4.2 Condiții pentru conexiunea DC

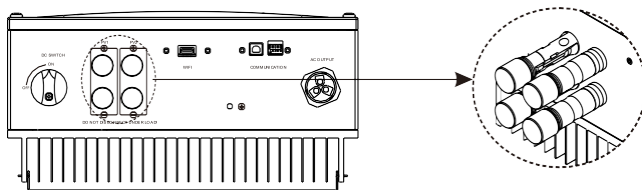

Invertorul monofazat SP6000 are 2 intrări independente: intrare A și intrare B

Desenul diagramei DC este prezentat mai jos, observați că conectorii sunt împerecheați (conectori masculin și feminin). Conectorii pentru rețele fotovoltaice și invertoare sunt conectori H4;

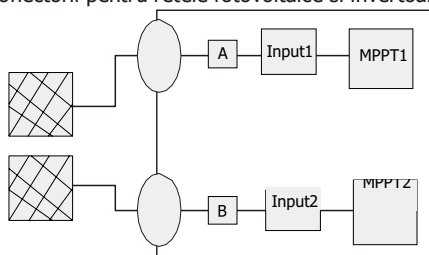

Sugestii pentru modulele fotovoltaice în siruri:

▶ Același tip de modul

▶ Același număr de module PV într-o serie



caution

Daca invertorul nu este echipat cu un intrerupator DC, dar acest lucru este obligatoriu in tara de instalare, instalati un intrerupator DC extern.  
Urmatoarele valori limita la intrarea DC a invertorului nu trebuie depasite:

Model	Curent maxim de intrare intrarea A si B
SP6000	11A

### 5.4.3 Conectarea rețelei fotovoltaice (intare DC)



danger

Înainte de a conecta rețeaua fotovoltaică, asigurați-vă că intrerupatorul DC și intrerupatorul AC sunt deconectate de la invertor. NU conectați sau deconectați NICIODATA conectorii DC sub sarcină.

Asigurați-vă că tensiunea maximă în circuit deschis (Voc) a fiecărui sir fotovoltaic este mai mică de 550 Vcc.

Verificați proiectarea instalației fotovoltaice. Tensiunea max. în circuit deschis, care poate apărea la temperatura panourilor solare de -10°C, nu trebuie să depășească tensiunea max. de intrare a invertorului.



warning

Operarea necorespunzătoare în timpul procesului de cablare poate cauza rani fatale operatorului sau daune irecuperabile invertorului. Lucrările de cablare pot fi efectuate numai personalul calificat.

### 5.5 Impământarea invertorului

Invertorul trebuie conectat la conductorul de împământare CA al rețelei de distribuție a energiei prin borna de împământare (PE) .  $\neq$



warning

Datorită designului fără transformator, polul pozitiv DC și polul negativ DC al rețelelor fotovoltaice nu este permis să fie împământat.

## 6. Punere in functiune

### 6.1 Ecranul LED

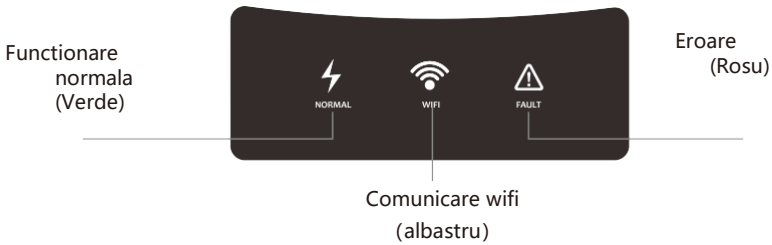

LED verde	Aprins continuu	Stare normala de functionare
	Clipeste	In asteptare
LED albastru	Clipeste	Comunicare wifi normala
LED rosu	Aprins continuu	Eroare
	Clipeste	Executare program sau alarma

### 6.2 Conexiune WiFi

Va rugam sa consultati Ghidul de instalare rapida Wi-Fi Plug14.

## 7. Pornire si Oprire invertor

### 7.1 Pornire invertor

1. Conectati intrerupatorul de curent alternativ al invertorului.
2. Porniti comutatorul de curent continuu, iar invertorul va porni automat cind tensiunea de intrare este mai mare de 100V.

### 7.2 Oprire invertor

	Nu deconectati conectorii DC sub sarcina.
---	---

Pasi de urmat:

- Deconectati intrerupatorul de circuit de la o retea monofazata si impiedicati-l sa fie reactivat.
- Opriti comutatorul de curent continuu.
- Verificati starea de functionare a invertorului.
- Se asteapta pina cind LED-ul, afisajul trebuie sa se stinga, invertorul este oprit.

## 8. Intretinere si curatare

### 8.1 Verificarea disiparii caldurii

Daca invertorul isi reduce regulat puterea de iesire din cauza temperaturii ridicate, va rugam sa imbunatatiti starea de disipare a caldurii. Poate trebuie sa curatati radiatorul.

### 8.2 Curatarea invertorului

Daca invertorul este murdar, opriti intrerupatorul AC si intrerupatorul DC, asteptind oprirea invertorului, apoi curatati capacul carcasei, afisajul si LED-urile folosind doar o cirpa umeda. Nu utilizati agenti de curatare (de exemplu, solventi sau abrazivi).

### 8.3 Verificarea deconectarii DC

Verificati la intervale regulate daune vizibile din exterior si decolorare a deconectorului DC si a cablurilor. Daca exista vreo deteriorare vizibila a deconectorului DC, sau decolorare vizibila sau deteriorare a cablurilor, contactati instalatorul.

O data pe an, rotiti comutatorul rotativ al deconectorului DC din pozitia Pornit in pozitia Oprit de 5 ori consecutiv. Aceasta curata contactele comutatorului rotativ si prelungeste rezistenta electrica a deconectorului D, contactele comutatorului rotativ si prelungeste rezistenta electrica a DC Disconnect.

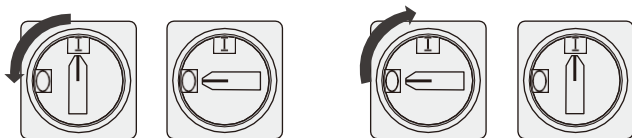

## 9. Probleme si solutii

Uneori, invertorul fotovoltaic nu functioneaza normal, recomandam urmatoarele solutii pentru depanarea comuna. Urmatorul tabel poate ajuta tehnicianul sa inteleaga problema si sa ia masuri.

<b>Mesaj eroare</b>	<b>Descriere</b>	<b>Sugestie</b>
Lipsa conexiune retea publica	Nicio retea de energie conectata sau pana de curent la retea de utilitati.	1. Verificati cablajul AC, in special firul de impamintare 2. Contactati furnizorul sau instalatorul
Eroare de temperatura a invertorului	Eroare NTC	1. Reporniti invertorul. 2. Daca mesajul de eroare inca persista, contactati furnizorul sau instalatorul
Eroare tensiune DC prea mare	Tensiunea de intrare DC depaseste valoarea maxima tolerabila.	1. Deconectati imediat comutatorul DC.
Defectiune la tensiunea retelei	Tensiunea retelei de utilitati este in afara intervalului permis.	1. Verificati tensiunea retelei. 2. Daca mesajul de eroare persista in ciuda faptului ca tensiunea retelei se afla in intervalul tolerabil, contactati furnizorul sau instalatorul
Eroare de frecventa a retelei	Frecventa in afara intervalului permis a retelei electrice.	1. Verificati frecventa retelei. 2. Daca mesajul de eroare este afisat in ciuda faptului ca frecventa retelei se afla in intervalul tolerabil, contactati contactati furnizorul sau instalatorul.
Eroare PV ISO	Problema de izolare	1. Verificati daca carcasa panoului este impamintat corect. 2. Verificati daca invertorul este impamintat corespunzator. 3. Verificati daca intrerupatorul de curent continuu se uda. 4. Daca mesajul de eroare este afisat in ciuda verificarii de mai sus, contactati furnizorul sau instalatorul
DCI prea mare	Curentul de iesire DC prea mare	1. Reporniti invertorul. Daca mesajul de eroare inca exista, contactati furnizorul sau instalatorul
Daune GFCI	Deteriorarea dispozitivului GFCI	1. Reporniti invertorul. Daca mesajul de eroare inca exista, contactati furnizorul sau instalatorul.
Eroare la senzorul Hall	Eroare HCT	1. Reporniti invertorul. 2. Daca mesajul de eroare inca exista, contactati furnizorul sau instalatorul.
Eroare releu	Eroare releu	1. Reporniti invertorul. 2. Daca mesajul de eroare inca exista, contactati furnizorul sau instalatorul.
Eroare comunicare	Eroare comunicare CPU	1. Reporniti invertorul. 2. Daca mesajul de eroare inca exista, contactati furnizorul sau instalatorul.
Eroare Soft FW	Soft FW nu se potriveste	1. Reporniti invertorul. 2. Daca mesajul de eroare inca exista, contactati furnizorul sau instalatorul.

Eroare PE	Fara fir de impamintare sau contact slab.	1.verificati PE Daca mesajul de eroare inca exista, contactati furnizorul sau instalatorul
-----------	---	---

Nota: Daca sugestiile nu functioneaza, va rugam sa conectati furnizorul sau instalatorul.

## 10. Demontarea si depozitarea

### 10.1 Demontarea invertorului

1. Deconectati invertorul asa cum este descris in sectiunea 7.
2. Deconectati toate cablurile de la invertor.



caution

#### **Pericol de arsuri din cauza pieselor fierbinti ale carcasei!**

Asteptati 20 de minute inainte de a demonta pina cind carcasa s-a racit.

3. Insurubati toate presetupele.
4. Ridicati invertorul de pe suport si desurubati suruburile suportului.

### 10.2 Ambalarea invertorului

Daca este posibil, impachetati intotdeauna invertorul in cutia sa originala si asigurati-l cu curele de tensionare. Daca nu mai este disponibil, puteti utiliza si o cutie echivalenta. Cutia trebuie sa poata fi inchisa complet si facuta sa suporte atat greutatea, cit si dimensiunea invertorului.

### 10.3 Depozitarea invertorului

Depozitati invertorul intr-un loc uscat, unde temperaturile sunt intotdeauna intre -25°C si +60°C.

### 10.4 Aruncarea invertorului



Nu aruncati invertoarele sau accesoriile defecte impreuna cu deseurile menajere. Va rugam sa respectati reglementarile privind eliminarea deseurilor electronice care se aplica la locul de instalare in acel moment. Asigurati-va ca vechea unitate si, daca este cazul, orice accesorii sunt eliminate in mod corespunzator.

## 11. Date tehnice

### 11.1 Specificatii

Model	SP6000
Intrare (DC)	
Putere fotovoltaica max.recomandata (pentru modulul STC)	7000W
Tensiune DC max	550V
Tensiunea de pornire	100V
Interval de tensiune PV	70V-550V
Interval tensiune de lucru MPP /tensiune nominala	80V-550V
Interval de tensiune DC la sarcina completa	286-500V



Curent maxim de intrare per sir de tracker A/ tracker B	11A/11A
Numarul de trackere MPP independente/siruri de caractere per tracker MPP	2/1
Conexiune DC	H4/MC4
<b>Iesire (AC)</b>	
Putere nominala de iesire AC	6000W
Putere aparenta max.AC	6000VA
Curent max. de iesire	27.3A
Interval de tensiune nominala AC	220V/230V/240V;180Vac-280Vac
Interval de frecventa a retelei AC	50±5Hz
	60±5Hz
Factorul de faza la puterea ratei	1
Factor de putere de deplasare, configurabil	0.8leading. 0.8lagging
THDI	< 3%
Conexiune AC	Monofazat
<b>Eficienta</b>	
Eficienta maxima	97.40%
Eficienta ponderata	97%
Eficienta MPPT	99.50%
<b>Protectii</b>	
Protectia insulei	Da
Protectie la supracurent la iesire	Da
Protectie la supratensiune la iesire	Da
Protectie la inversarea polaritatii DC	Da
Valoarea comutatorului DC pentru fiecare MPPT	Da
Monitorizare eroare impamantare	Da

Unitate integrata de monitorizare a curentului de scurgere sensibila la toti polii	Da
<b>General</b>	
Dimensiuni (W/H/D) in mm	355*412*201
Greutate	16kg
Interval temperatura de lucru	-25°C-+60°C cu o scadere a performatelor peste 45°C
Zgomot (tipic)	≤25dB(A)
Altitudine	2000m(6560ft) fara reducere a performatelor
Auto-consum	< 1W
Topologie	fara transformator
Racire	Natural
Protectie	Ip65
Umiditate relativa	95%
Conexiune AC	conector
Ecran	LED
Interfata:USB/WI-FI/Ethernet	da/da/optional

## 12. Instalarea sistemului fotovoltaic

Instalare cu mai multe invertoare pe un sistem monofazat

(A) Un singur inverter

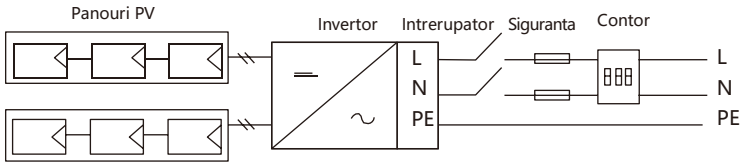

(B) Mai multe invertoare

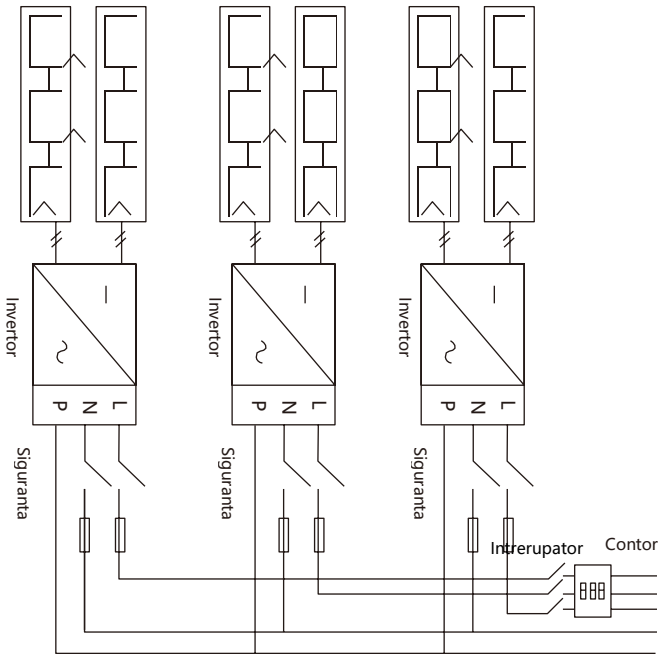

### 13. Monitorizare date

Deconectati-va de la WiFi, conectati-va la internet, accesati [http://shinemonitor.com/index\\_en.html](http://shinemonitor.com/index_en.html)

#### 13.1 Inregistrati-va si autentificati-va.

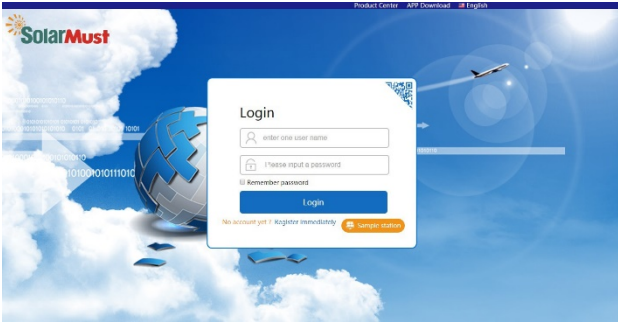

#### 13.2 Creati o noua centrala electrica (power station) pentru PLANT

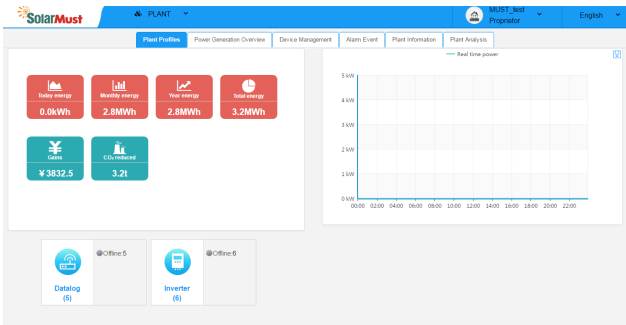

#### 13.3 Click **Add data collector** in **Device management** si adaugati noul dispozitiv WiFi in PLANT

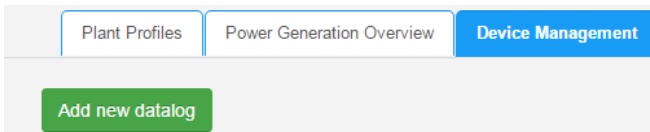

Numele dispozitivului WiFi si invertorul vor aparea in partea stanga a paginii. Ecranul invertorului va fi verde.

Add new datalog

\* Datalog PN      Wifi serial number      datalog name      Wifi serial number

cancel      confirm

Datalog PN	Datalog Name	Datalog Status	Timezone	Firmware	Load Count	Operation/Modify/Restart/Debug/Delete/Upgrade
X1417A20023714	X1417A20023714	Offline	g	1.8.1.0	1	[Icons]

**Declaratie UE de conformitate simplificata**

SC ONLINESHOP SRL declara ca **Invertor solar ON Grid PNI GreenHouse SP6000** este in conformitate cu Directiva EMC 2014/30/EU si Directiva RED 2014/53/UE. Textul integral al declaratiei UE de conformitate este disponibil la urmatoarea adresa de internet:  
<https://www.mypni.eu/products/6202/download/certifications>

Download the software "SolarPowerMonitor2.2.81"  
Descarcati software-ul "SolarPowerMonitor2.2.81"



<https://bit.ly/2PyyLg6>