



PNI SafeHome PT720MW

Smart video door phone / Interfon video inteligent



EN	User manual	3
RO	Manual de utilizare	17

Tuya Smart APP

Download the application **Tuya Smart** by accessing Google Play or the App Store or scan the QR codes below:

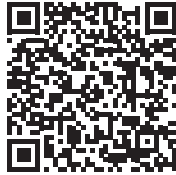

Android

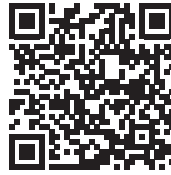

iOS

Add device in Tuya Smart application

1. Open the application, create an account and log in.
2. Add your device by pressing the **+** icon in the upper right corner of the screen or by pressing the **Add device** (this button appears when you do not have any devices added to the application).
3. Select the option **Video surveillance** on the left side of the screen.
4. From the list of devices on the right side of the screen, select **Smart Doorbell**



5. In the next interface, select the option **Ap Mode** from the upper right corner.
6. Then tick **Make sure the indicator is flashing quickly or a prompt tone is heard**. Click **Next**.
7. Select the WiFi network you want to connect to and add the password.
8. Enter the door phone settings menu in **System - Network settings - WiFi settings** and select **AP Mode**. The door phone will close and restart.

Note: to access the door phone settings menu, press the wheel on the upper right side of

the door phone . Move the wheel up and down to navigate the menu.

9. Enter the WiFi settings of the phone and connect to the network **SmartLife-Doorbell**.
10. Return to the application. The app will start scanning the devices.
11. Once your device was identified, you will receive the confirmation **Added Successfully**.
12. To finish, click the **Done** button.
- 13.

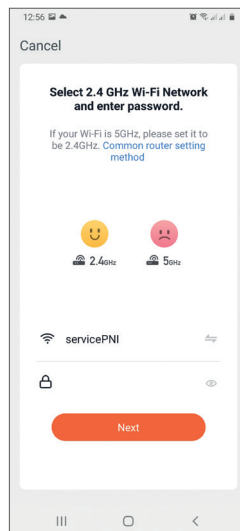
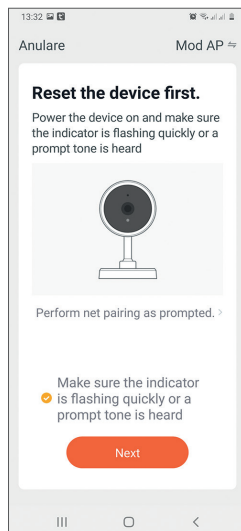
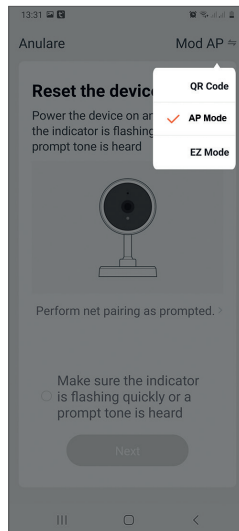
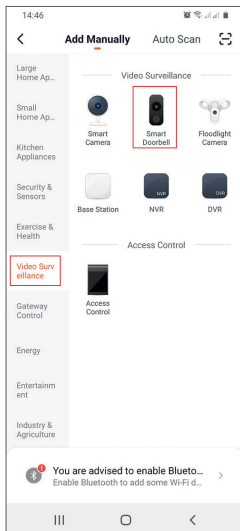
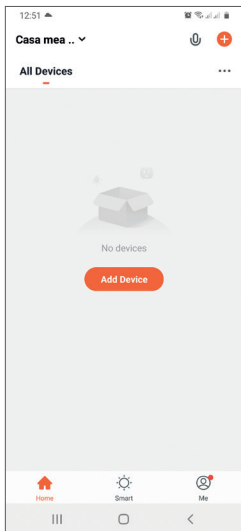

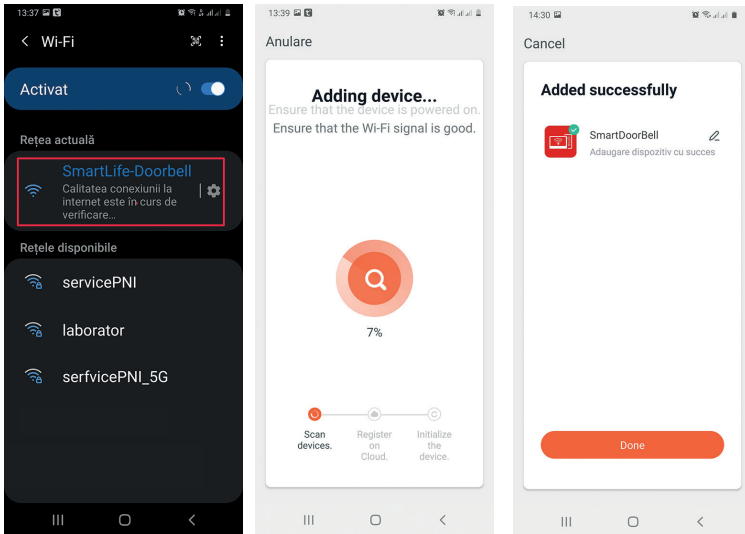

Device control from the application

Options:

1. Image capture: takes an image and saves it in the phone's memory
2. Intercom: press to talk to the person in front of the door
3. Recording: press to record video. The recording will be saved in the phone memory.
4. Unlock the lock 1
5. Channel change
6. Unlock the lock 2
7. View files saved on the SD card inserted in the door phone
8. View photos and videos saved in the phone memory

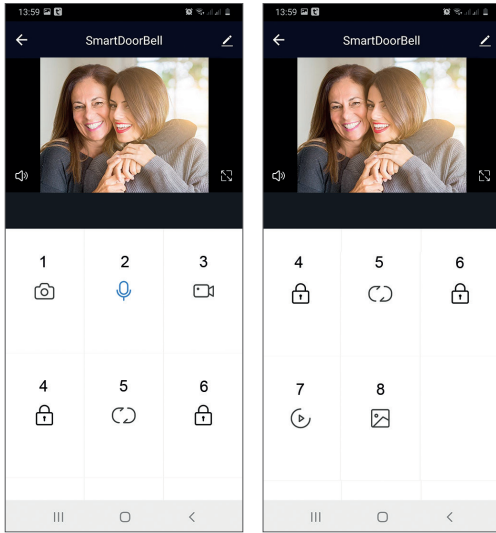







Indoor unit description



9. Power LED	15. Loudspeaker
10. Led door 1	16. Settings menu button
11. Led door 2	17. Micro SD card slot
12. TFT screen	18. Volume +
13. Touch buttons	19. Volume -
14. Microphone	

Symbols description

	<p>Access the menu Confirmation Up / Down</p>	<p>In the standby mode, press this button to enter the settings menu. Once you access the menu, push this button up or down to navigate the menu. Press this button to enter a specific menu item and confirm a setting. In Intercom mode, press this button to stop / restart recording. If you are in capture mode, press this button to capture an image. While playing audio, video or photo files, press this button to Stop or Play. In playback mode, long press this button to adjust the volume. The volume bar will appear on the screen.</p>
	<p>Volume + / Volume -</p>	<p>Turn this knob up and down to adjust the volume of the indoor unit.</p>
 <p>Transfer Call</p>	<p>Call transfer Internal call Image settings Refresh</p>	<p>In the standby mode, press and hold to make an internal call. During an external call, press to transfer the call. In Intercom mode, press to make the following settings: brightness, contrast, saturation, volume (adjust the sound from the external unit). Refresh: when connecting to the indoor unit PAL / NTSC CCTV cameras or the included outdoor camera and a CVBS / AHD CCTV camera or only the included outdoor camera and no image appears on the monitor, press the “R” symbol on the screen.</p>
 <p>Monitoring</p>	<p>Monitor</p>	<p>Select the video source.</p>
 <p>Talk</p>	<p>talk</p>	<p>Click to talk to the visitor</p>
 <p>Unlock</p>	<p>Unlock</p>	<p>Click to allow visitor access, unlocking the lock.</p>
 <p>Hang up</p>	<p>Hang up Back Exit</p>	<p>Click to end the conversation with the visitor. Back to the previous page (when you are in the settings menu). Exit the settings menu, return to standby mode.</p>

Connection diagram 1

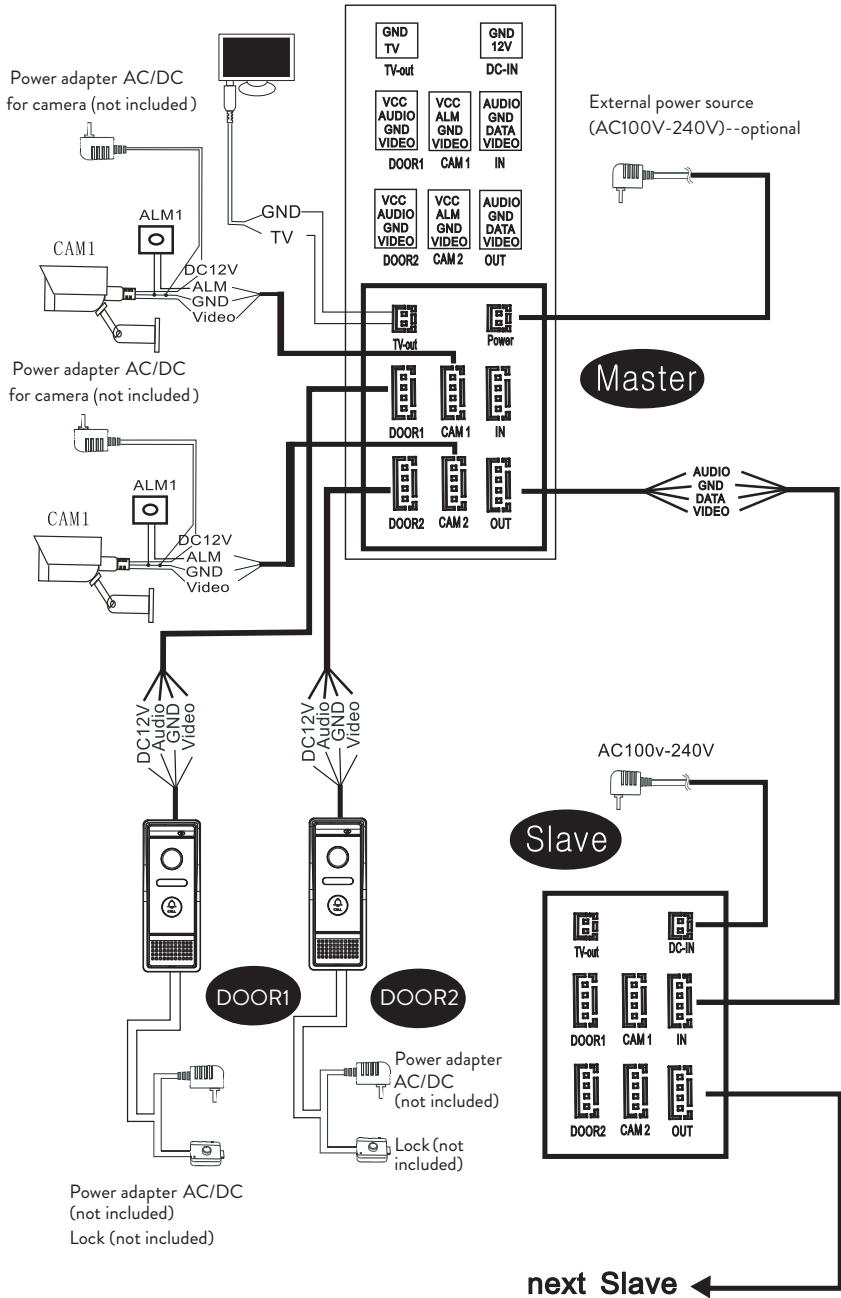

Outdoor unit connection diagram

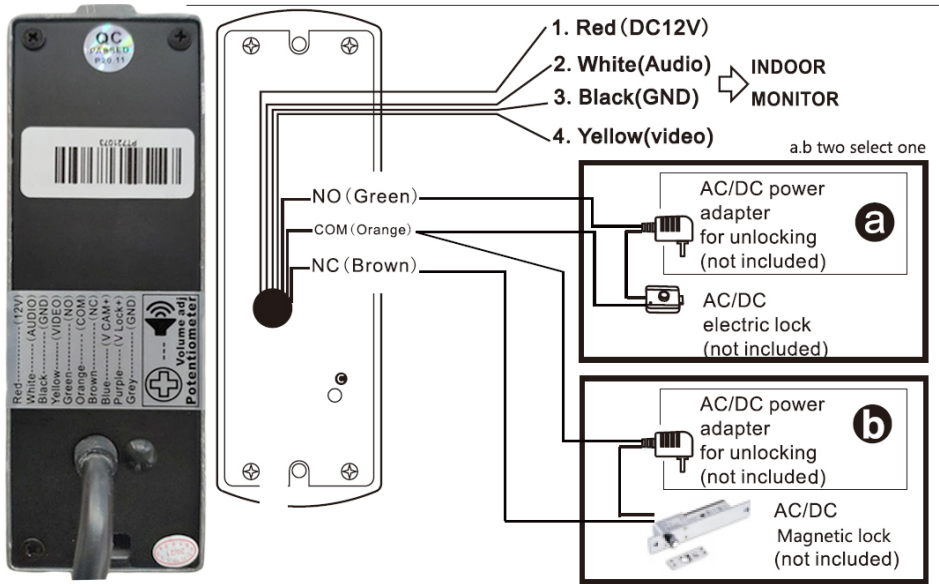

Note:

The system supports the connection of a Normal Open (NO) electromagnetic lock. This means that in standby mode, the relay is open and the lock is closed. When the Unlock button on the internal unit is pressed, the relay closes and the lock opens.

You must connect electromagnetic lock according to outdoor connection diagram, and power the lock with dedicated AC/DC adapter (not included).

Power the indoor unit with the power adapter included in the package.

Connection diagram 2

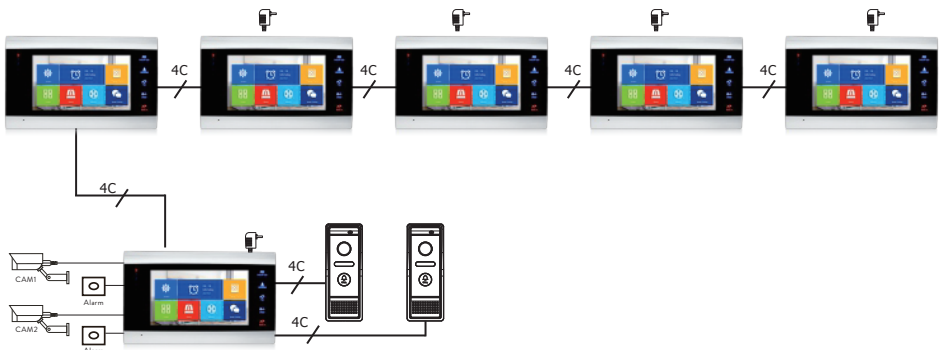

Cable connections recommendations

For connections, use the below cable types:

1. Standard insulated and uninsulated type cable 4C.

Distance ≤ 28 m ($4 \times 0.2 \text{mm}^2$)

Distance ≤ 50 m ($4 \times 0.3 \text{mm}^2$)

Distance ≤ 80 m ($4 \times 0.5 \text{mm}^2$)



2. Standard uninsulated cable type 3C + video cable (75-3)

Distance ≤ 100 m

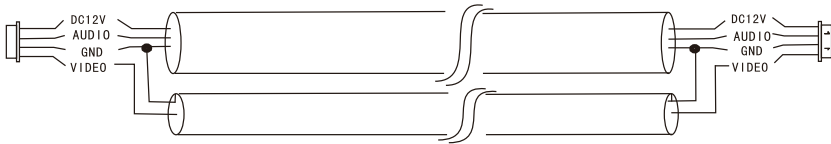

3. Uninsulated CAT5 network cable (not recommended)



Distance ≤ 50 m



Video door phone usage

1. The visitor presses the call key on the outdoor unit of the door phone.
2. The ringtone will be heard on both the indoor and outdoor units. The default maximum call duration is 30 seconds.
3. Immediately, the visitor's image appears on the indoor unit screen (image taken by the camera on the outdoor unit).
4. To talk to the visitor, press the key **Talk** . The ringtone is interrupted. The maximum talk time is 120 seconds.

*Note: If no one answers the call, the visitor will hear the message **Please leave a message** and will have a maximum of 60 seconds to leave a message.*

5. If you want to allow the visitor access, press the key **Unlock** . The lock will unlock.
6. Press the key **Hang up**  to end the conversation.

*Note: After pressing **Hang up**  key, both the voice and the image of the visitor will be heard for another 20 seconds. This feature allows the host to ensure that the visitor has entered on site.*

If you have inserted a micro SD card into the indoor unit, the whole process will be recorded on the card or images will be captured (depending on the settings made). Access the menu **Mode - Record mode** and select **Video** or **Snapshot**.

Notes:

*During a conversation, you will not be able to press the button **Monitor**  to change the video source.*

During a conversation, if a call comes in from another connected camera, the indoor unit will emit a “du ... du ... du ...” warning sound.

Video source

Press the key **Monitor**  to change the video source:

DOOR1 - will display the image taken by the camera connected to the input DOOR1

CAM1 - will display the image taken by the camera connected to the input CAM1

DOOR2 - will display the image taken by the camera connected to the input DOOR2

CAM2 - will display the image taken by the camera connected to the input CAM2

STANDBY - the date and time will be displayed on the screen for a few seconds, after which the monitor will turn off.



Note: If you have connected only one camera, you can deactivate the other outputs in the setup menu.

Call transfer

This function requires at least two indoor units and one outdoor unit, connected to each other.

1. The visitor presses the call button on the external unit.
2. The image taken by the camera immediately appears on the monitor.
3. Long press the button **Transfer call**  until the icons below appear on the screen:





4. Rotate the wheel  up and down until you reach the indoor unit to which you want to transfer the call. Press the button  to confirm the transfer.
5. The selected indoor unit will get the call.
6. Press **Talk** key to talk with the visitor, **Unlock** to open the door and **Hang up** to end the conversation.

Internal call

In standby mode, press and hold the button **Transfer call**  until the icons below appear on the screen:



7. Rotate the wheel  up and down until you reach the indoor unit to which you want to communicate with. Press the button  to confirm the call.
8. The selected indoor unit will ring.
9. Press **Talk** to talk and **Hang up** to end the conversation.

Settings menu

In **standby mode**, either the date and time or the photos saved on the micro SD card can appear on the indoor unit screen (the mode **Photo frame** must be activated; for

this access the menu **System**).

Important:

Specialized folders must be created on the SD card:

- “**ring**” - where the audio files will be saved and where the ringtone will be downloaded from
- “**user**” - where photos will be saved and where photos will be taken from for standby mode
- “**music**” - where the audio (music) files will be saved
- “**update**” - where the firmware update file will be saved

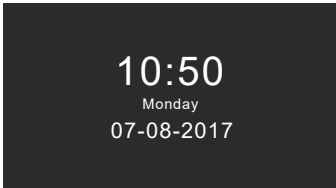





Standby mode with date and time



Standby mode with picture

If the user does not perform any operation for 60 seconds, the monitor will return to standby mode for another 60 seconds after which it will turn off..

1. In standby mode, press  to access the menu.
2. Rotate the wheel  up and down to navigate the menu.
3. Press the wheel  to enter the selected sub-menu options.
4. Press the button  to exit the menu.

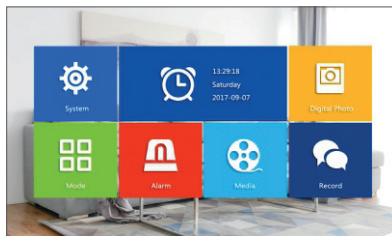

1. System

Select the menu **System**. It includes **Language**, **Time**, **System info**, **Ringtone**, **Volume** and **Network settings**.

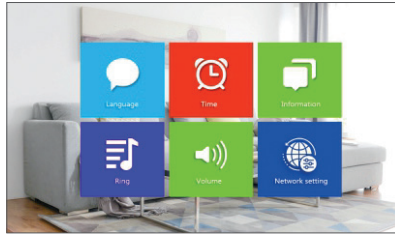

Language - select the menu display language: English, Russian, German, Polish.

Time - select date and time.

System info - displays firmware version, processor model, micro SD card space (system supports up to 32GB), ID and MAC.

Ringtone - select the ring bell for the indoor unit Door1 and Door2:

Default or **Custom** (select one of the songs saved on the micro SD card).

Note: Save the audio files in the “ring” folder on the micro SD card. Name the files: ring_1 ... ring_12.

Volume - you can set the ring duration and ring volume intensity in three different time periods.

Network settings - access this sub-menu when you want to pair the intercom with the Tuya Smart application. See page 3 for more details.

2. Photo frame

Access this menu to activate the standby mode with picture.

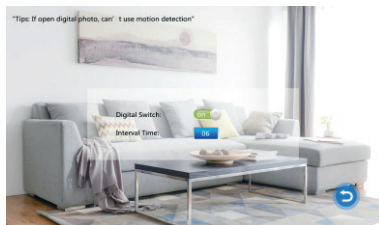

Note:

Photos must be saved in the “user” folder on the micro SD card.

If you have the Photo frame function activated, the Motion detection function will not work.

3. Mode

Options:

Set machine ID - from 01 to 06. 01 is the **Master indoor unit**. 02 - 06 are the **Slave indoor units**.

Door 2 status - enable or disable the output on Door 2.

Door 1 unlock time - between 02 - 10 seconds. Set how long the lock will stay open.

Door 2 unlock time - between 02 - 10 seconds. Set how long the lock will stay open.

Record mode - set the recording mode: video or snapshot.

Motion detection - Options: **Closed, Door 2, Door 1, Camera 2, Camera 1**. You can activate the motion detection function on a single channel. When motion is detected, the system will start video recording or will capture images (depending on the setting from the previous option, **Record mode**.)

Message - enable / disable messages.

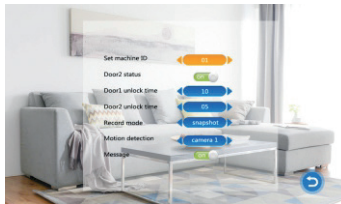

4. Alarm

• Alarm record

Options:

Video (when motion is detected, the system will start the video recording which will be saved on the micro SD card).

Snapshot (when motion is detected, the system will capture images that will be saved to the micro SD card).

- **Sensor type 1** - Options: **NO** (Normal open) and **NC** (Normal Close)
- **Cam 1** - enable / disable output Cam 1.
- **Cam 1 ring time** - between 02 - 20 seconds
- **Sensor type 2** - Options: **NO** (Normal open) and **NC** (Normal Close)
- **Cam 2** - enable / disable output Cam 1.
- **Cam 2 ring time** - between 02 - 20 seconds



5. Media

Access this menu to play audio (music) and image (photos) files on the micro SD card.

Note: save the audio files in the “music” folder on the micro SD card, and the image files in the “user” folder.

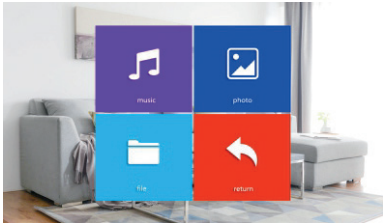

6. Record center

- **Video info** - includes video recordings from the external unit.
- **Photo info** - includes images captured by the external unit.

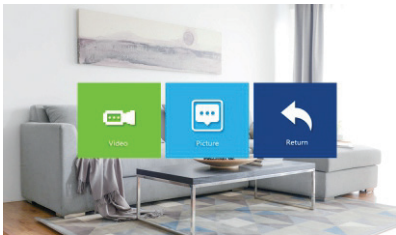

Technical specifications

System	Supports 6 indoor units + 2 outdoor units + 2 CCTV cameras
Input video signal	CVBS, CVI, TVI, AHD2.0
Monitor	7 inch
Monitor resolution	1024 x 600 px
Motion detection	Yes
Call mode	Intercom / Duplex
Maximum capacity of micro SD card	32GB, Classe 10
Power supply	230V (with the power adapter included) 12V (external power source)
Current	max. 600mA
Working temperature	-26°C ~ +60°C

Aplicatia Tuya Smart

Descarcati aplicatia **Tuya Smart** accesand Google Play sau App Store sau scanati codurile QR de mai jos:



Android



iOS

Adaugare dispozitiv in aplicatia Tuya Smart

1. Deschideti aplicatia, creati-va cont si autentificati-va.
2. Adaugati dispozitivul dvs. apasand pictograma + din coltul dreapta sus al ecranului sau apasand butonul **Add device** (acest buton apare atunci cand nu aveti nici un dispozitiv adaugat in aplicatie).
3. Selectati din partea stanga a ecranului optiunea **Video surveillance**.
4. Din lista de dispozitive din partea dreapta a ecranului, selectati **Smart Doorbell**



5. In interfata urmatoare selectati din coltul dreapta sus optiunea **Ap Mode**.
6. Apoi bifati **Make sure the indicator is flashing quickly or a prompt tone is heard**. Click **Next**.
7. Selectati reseaua WiFi la care doriti sa va conectati si adaugati parola.
8. Intrati in meniul de setari al interfonului in **System - Network settings - WiFi settings** si selectati **AP Mode**. Interfonul se va inchide si va reporni.

Nota: pentru a accesa meniul de setari al interfonului, apasati rotita din partea laterala dreapta a acestuia . Miscati rotita in sus si in jos pentru a naviga prin meniu.

9. Intrati in setarile WiFi ale telefonului si conectati-va la rețeaua **SmartLife-Doorbell**.
10. Intoarceti-va in aplicatie. Aceasta va incepe scanarea dispozitivelor.
11. Dupa ce va identifica dispozitivul dvs., veti primi confirmarea **Added Successfully**.
12. Pentru a finaliza, faceti click pe butonul **Done**.

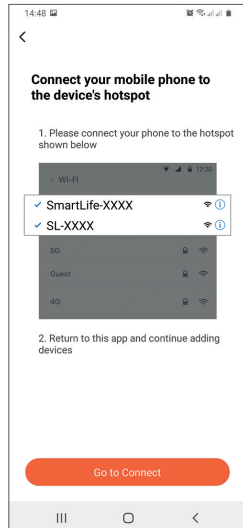
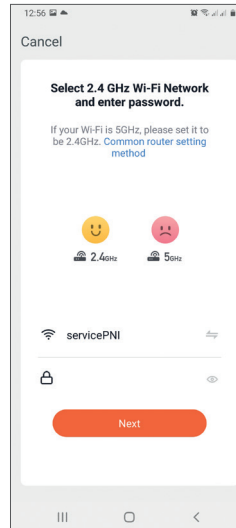
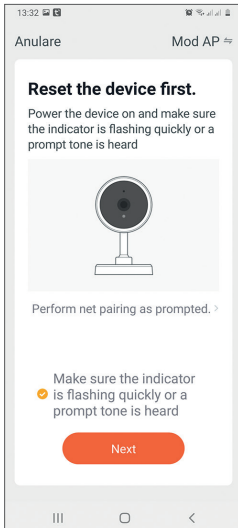
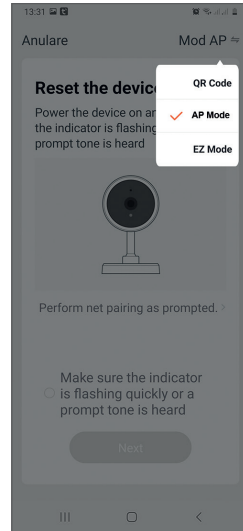
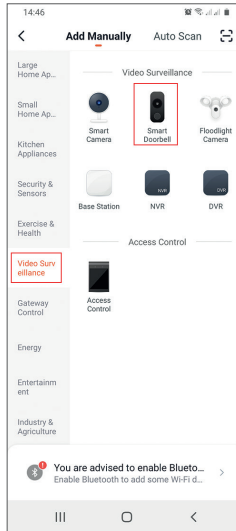
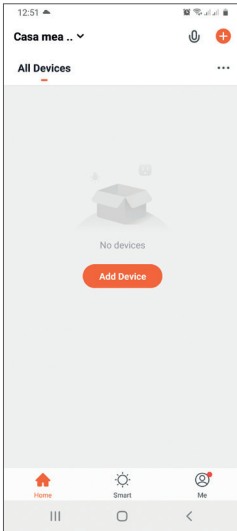

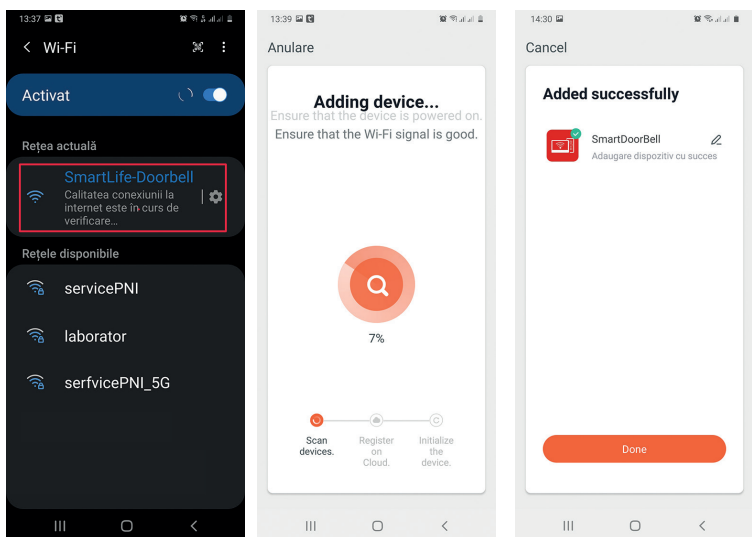

Control dispozitiv din aplicatie

Optiuni:

1. Captura imagine: preia o imagine si o salveaza in memoria telefonului
2. Intercom: apasati pentru a vorbi cu persoana aflata in fata usii
3. Inregistrare: apasati pentru a inregistra video. Inregistrarea va fi salvata in memoria telefonului.
4. Deblocare yala 1
5. Schimbare canal
6. Deblocare yala 2
7. Vizualizare fisiere salvate pe cardul SD introdus in interfon
8. Vizualizare foto si video salvate in memoria telefonului

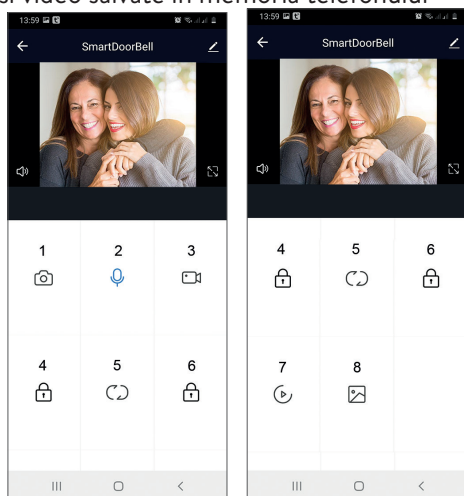

Descriere unitate de interior



9. Led alimentare
10. Led usa 1
11. Led usa 2
12. Ecran TFT
13. Butoane tactile
14. Microfon
15. Difuzor
16. Buton meniuri setari
17. Slot card micro SD
18. Volum +
19. Volum -

Descriere simboluri

	<p>Accesare meniuri setari Confirmare selectie Sus / Jos</p>	<p>In modul standby, apasati acest buton pentru a intra in meniul de setari. Odata accesat meniul, impingeti acest buton in sus sau in jos pentru a naviga prin meniul. Apasati acest buton pentru a intra intr-o anumita rubrica din meniul si pentru a confirma o setare. In modul Intercom, apasati acest buton pentru a opri/reporni inregistrarea. Daca suneti in modul captura, apasati acest buton pentru a realiza o captura de imagine. In timpul redarii fisierelor audio, video sau foto, apasati acest buton pentru Stop / Play. In modul redare, apasati lung acest buton pentru a regla volumul. Pe ecran va aparea bara de volum.</p>
---	--	--







	Volum + / Volum -	Rotiti acest buton in sus si in jos pentru a regla volumul unitatii de interior.
 Transfer Call	Transfer apel Apel intern Setari imagine Refresh	<p>In modul standby, apasati lung pentru a efectua un apel intern.</p> <p>In timpul unui apel extern, apasati pentru a transfera apelul.</p> <p>In modul Intercom, apasati pentru a face urmatoarele setari: luminozitate, contrast, saturatie, volum (reglati sunetul provenit de la unitatea externa).</p> <p>Refresh: cand conectati la unitatea de interior camere CCTV PAL/NTSC sau camera de exterior inclusa si o camera CCTV CVBS/AHD sau doar camera de exterior inclusa si pe monitor nu apare nici o imagine, apasati simbolul "R" de pe ecran.</p>
 Monitoring	Monitorizare	Selectati sursa video.
 Talk	Vorbiti	Apasati pentru a vorbi cu vizitatorul
 Unlock	Deblocati	Apasati pentru a permite accesul vizitatorului, deblocand yala.
 Hang up	Inchide o convorbire Inapoi Iesire	<p>Apasati pentru a incheia convorbirea cu vizitatorul.</p> <p>Inapoi la pagina anterioara (cand va aflati in meniul de setari).</p> <p>Iesire din meniul de setari, intoarcerea la modul standby.</p>

Diagrama conexiuni 1



Unitate de exterior - descriere conexiuni

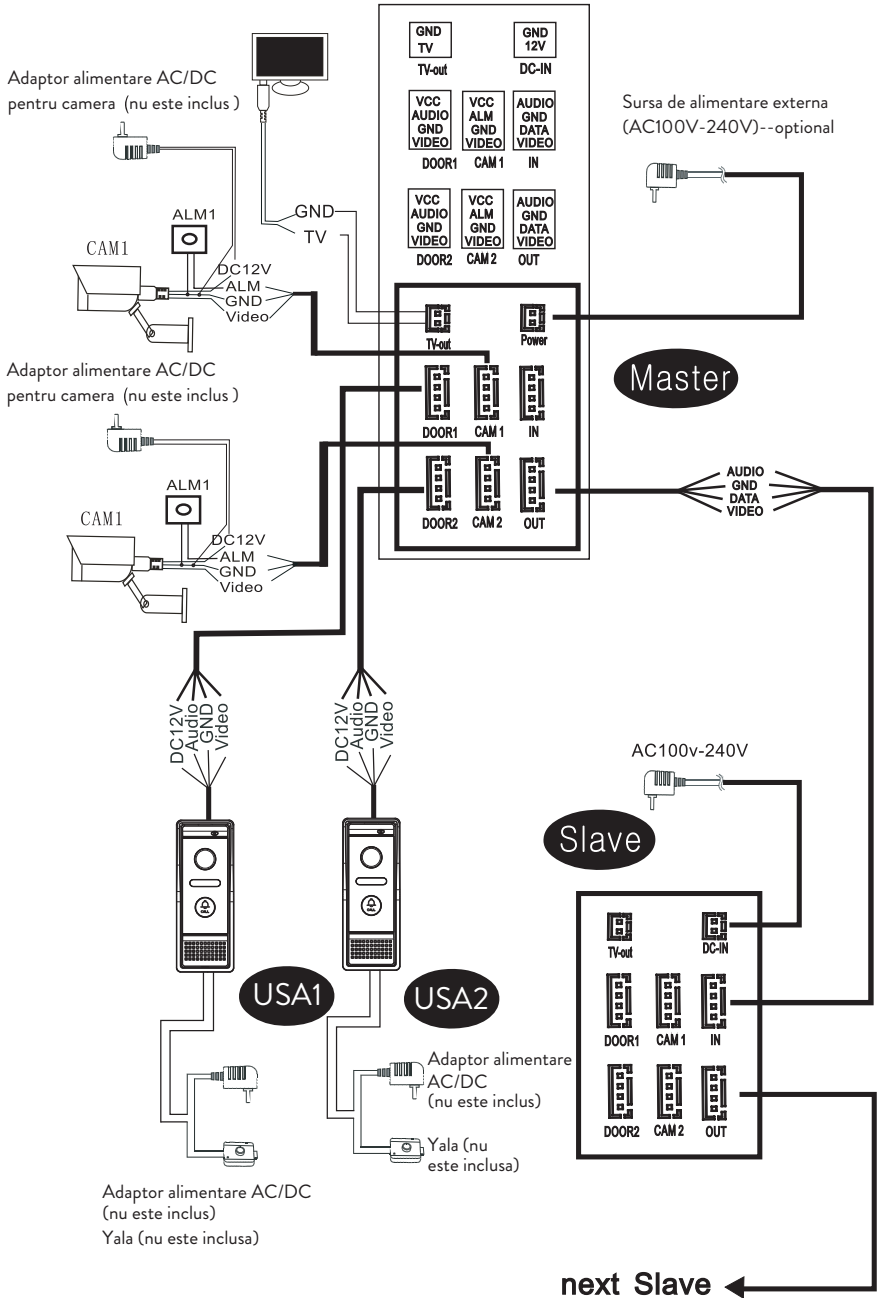
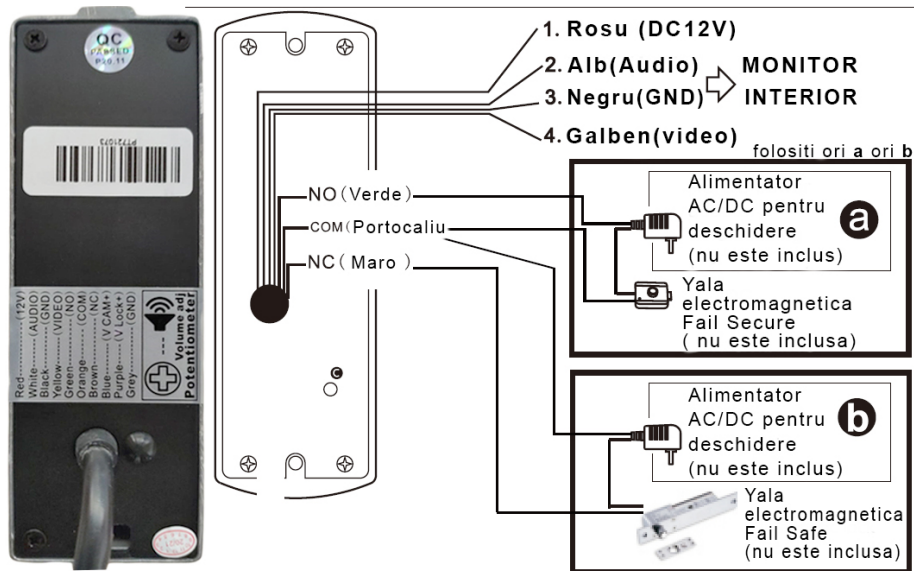

Note:

Sistemul suporta conectarea unei yale electromagnetice de tip Normal Open (NO). Asta inseamna ca in modul standby, releul este deschis si yala inchisa. Cand se apasa butonul Deblocare de pe unitatea interna a interfonului, releul se inchide si yala se deschide. **Conectati yala electromagnetica (achizitionata separat) conform diagramei de conexiuni de mai sus impreuna cu alimentatorul AC/DC compatibil (achizitionat separat).**

Alimentati unitatea de interior a interfonului cu adaptorul de alimentare inclus in pachet.

Diagrama conexiuni 2

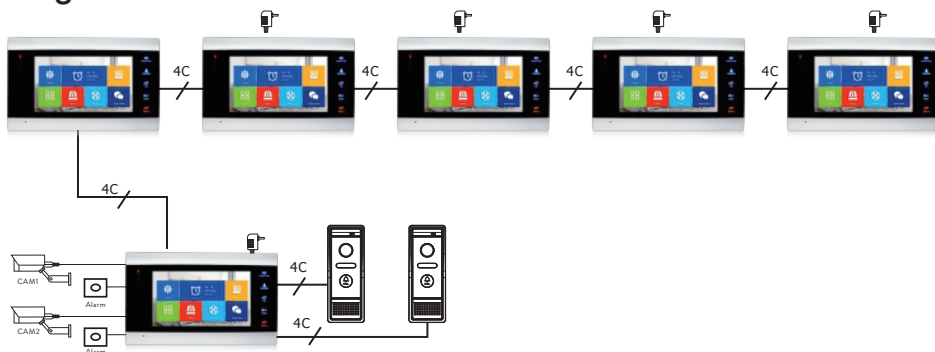

Recomandari cablu conexiuni

Pentru conexiuni, folositi tipurile de cablu de mai jos:

1. Cablu standard izolat si neizolat tip 4C.

Distanta ≤ 28 m ($4 \times 0.2 \text{mm}^2$)

Distanta ≤ 50 m ($4 \times 0.3 \text{mm}^2$)

Distanta ≤ 80 m ($4 \times 0.5 \text{mm}^2$)



2. Cablu standard neizolat tip 3C + cablu video (75-3)

Distanta ≤ 100 m

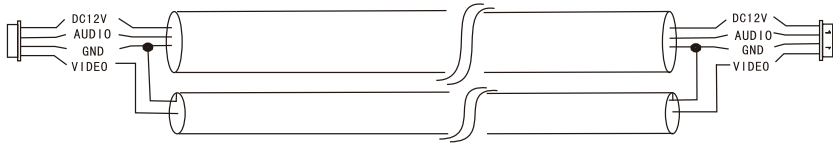

3. Cablu de retea CAT5 neizolat (nu este recomandat)



Distanta ≤ 50 m



Utilizare

1. Vizitatorul apasa tasta de apel pe unitatea de exterior a interfonului.
2. Pe ambele unitati (de interior si de exterior) se va auzi tonul de apel. Durata maxima implicita de apel este de 30 secunde.
3. Imediat, pe ecranul unitatii de interior apare imaginea vizitatorului (imagine preluata de camera de pe unitatea exterior).
4. Pentru a vorbi cu vizitatorul apasati tasta **Talk** (Vorbeste) . Tonul de apel se intrupe. Durata maxima de conversatie este de 120 secunde.

*Nota: Daca nu raspunde nimeni la apel, vizitatorul va auzi mesajul **Please leave a message** (Va rugam sa lasati un mesaj) si va avea la dispozitie maxim 60 de secunde.*

5. Daca doriti sa permiteti vizitatorului accesul in incinta, apasati tasta **Unlock** (Deblocheaza) . Yala se va debloca.
6. Apasati tasta **Hang up** (Inchide)  pentru a incheia convorbirea.

*Nota: Dupa apasarea butonului **Hang up** (Inchide) , atat vocea cat si imaginea vizitatorului vor mai fi auzite timp de inca 20 secunde. Aceasta functie permite gazdei sa se asigure ca vizitatorul a intrat in incinta.*

Daca ati introdus un card micro SD in unitatea de interior, tot procesul va fi inregistrat pe card sau vor fi facute capturi de imagine (in functie de setarile facute). Accesati meniul **Mode - Record mode** si selectati **Video** sau **Snapshot**.

Note:

*In timpul unei conversatii, nu veti putea apasa butonul **Monitor**  pentru a schimba sursa video.*

In timpul unei conversatii, daca intra un apel de la o alta camera conectata, unitatea de interior va emite un sunet "du...du...du..." de avertizare.

Schimbare sursa video

Apasati tasta **Monitor**  pentru a schimba sursa video:

DOOR1 - va afisa imaginea preluata de camera conectata pe intrarea DOOR1
 CAM1 - va afisa imaginea preluata de camera conectata pe intrarea CAM1
 DOOR2 - va afisa imaginea preluata de camera conectata pe intrarea DOOR2
 CAM2 - va afisa imaginea preluata de camera conectata pe intrarea CAM2
 STANDBY - pe ecran va fi afisata data si ora timp de cateva secunde, dupa care monitorul se va stinge.



Nota: Daca ati conectat o singura camera, puteti dezactiva celelalte iesiri in meniul de setari.

Transfer apel

Pentru aceasta functie sunt necesare cel putin doua unitati de interior si o unitate de exterior, conectate intre ele.

1. Vizitatorul apasa butonul de apel de pe unitatea externa.
2. Pe monitor apare imediat imaginea preluata de camera video.
3. Apasati lung butonul **Transfer call** (Transfer apel)  pana cand pe ecran apar pictogramele de mai jos:





4. Rotiti butonul  in sus si in jos pana ajungeti la unitatea de interior catre care doriti sa transferati apelul. Apasati butonul  pentru a confirma transferul.
5. Unitatea de interior selectata va prelua apelul.
6. Apasati **Talk** pentru a vorbi cu vizitatorul **Unlock** pentru a debloca yala si **Hang up** pentru a inchide conversatia.

Apel intern

In modul standby, tineti apasat butonul **Transfer call** (Transfer apel)  pana cand pe ecran apar pictogramele de mai jos:



7. Rotiti butonul  in sus si in jos pana ajungeti la unitatea de interior cu care doriti sa comunicati. Apasati butonul  pentru a confirma apelul.
8. Unitatea de interior selectata va suna.
9. Apasati **Talk** pentru a raspunde si **Hang up** pentru a inchide conversatia.

Meniul de setari

In **modul standby**, pe ecranul unitatii de interior pot aparea fie data si ora, fie fotografiile salvate pe cardul micro SD (modul **Photo frame** trebuie sa fie activat;

pentru aceasta accesati meniul **System**).

Important:

Pe cardul SD trebuie create foldere specializate:

- “**ring**” - in care vor fi salvate fisierele audio si de unde va fi preluata melodia pentru sonerie
- “**user**” - in care vor fi salvate fotografiile si de unde vor fi preluate fotografiile pentru modul standby
- “**music**” - in care vor fi salvate fisierele audio (muzica)
- “**update**” - in care va fi salvat fisierul pentru update firmware

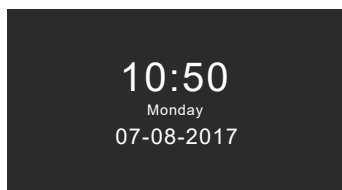





Modul Standby cu data si ora



Modul Standby cu fotografie

Daca utilizatorul nu efectueaza nici un fel de operatiune timp de 60 de secunde, monitorul se va intoarce la modul standby timp de alte 60 de secunde dupa care se va stinge.

1. In modul standby, apasati butonul  pentru a accesa meniul.
2. Rotiti butonul  in sus si in jos pentru a naviga prin meniu.
3. Apasati butonul  pentru a intra in optiunile sub-meniului selectat.
4. Apasati butonul  pentru a iesi din meniu.

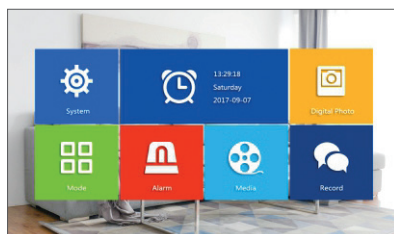

1. System

Selectati meniul System. Acesta include **Language**, **Time**, **System info**, **Ringtone**, **Volume** si **Network settings**.



Language - selectati limba de afisare a meniului: engleza, rusa, germana, poloneza.

Time - setati data si ora sistemului.

System info - afiseaza versiunea firmware-ului, modelul procesorului, spatiul pe cardul micro SD (sistemul suporta maxim 32GB), ID si MAC.

Ringtone - selectati melodia pentru soneria unitatii de interior Door1 si Door2:

Default sau **Custom** (selectati una dintre melodiile salvate pe cardul micro SD).

Nota: Salvati fisierele audio in folderul "ring" de pe cardul micro SD. Denumiti fisierele ring_1 ... ring_12.

Volume - puteti seta durata soneriei si intensitatea volumului soneriei in trei perioade de timp diferite.

Network settings - accesati acest sub-meniu cand doriti sa imperecheati interfonul cu aplicatia Tuya Smart. Mai multe detalii gasiti la pagina 20.

2. Photo frame

Accesati acest meniu pentru a activa modul standby cu fotografie de fundal.

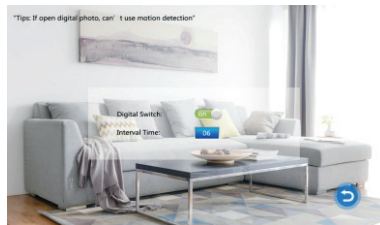

Note:

Fotografiile trebuie sa fie salvate in folderul "user" de pe cardul micro SD.

Daca aveti functia Photo frame activata, functia Motion detection (detectie miscare) nu va functiona.

3. Mode

Optiuni:

Set machine ID - de la 01 la 06. 01 este unitatea de interior **Master**. 02 - 06 sunt unitatile de interior **Slave**.

Door 2 status - activati sau dezactivati iesirea de pe Door 2.

Door 1 unlock time - intre 02 - 10 secunde. Setati timpul cat va ramane deschisa yala.

Door 2 unlock time - intre 02 - 10 secunde. Setati timpul cat va ramane deschisa yala.

Record mode - setati modul de inregistrare: video sau captura imagine.

Motion detection - Optiuni: **Closed** (dezactivat), **Door 2**, **Door 1**, **Camera 2**, **Camera 1**. Puteti activa functia de detectie miscare pe un singur canal. Cand se detecteaza miscare, sistemul va porni inregistrarea video sau va face capturi (in functie de setarea de la optiunea anterioara, **Record mode**.)

Message - activati/dezactivati mesajele.



4. Alarm

- Alarm record**

Optiuni:

Video (cand va fi detectata miscare, sistemul va porni inregistrarea video care va fi salvata pe cardul micro SD).

Snapshot (cand va fi detectata miscare, sistemul va realiza capturi care vor fi salvate pe cardul micro SD).

- **Sensor type 1** - Optiuni: **NO** (Normal open) si **NC** (Normal Close)
- **Cam 1** - activati/dezactivati iesirea Cam 1.
- **Cam 1 ring time** - valori cuprinse intre 02 - 20 secunde
- **Sensor type 2** - Optiuni: **NO** (Normal open) si **NC** (Normal Close)
- **Cam 2** - activati/dezactivati iesirea Cam 1.
- **Cam 2 ring time** - valori cuprinse intre 02 - 20 secunde



5. Media

Accesati acest meniu pentru a reda fisierele audio (muzica) si imagine (fotografii) de pe cardul micro SD.

Nota: salvati fisierele audio in folderul “music“ de pe cardul micro SD, iar fisierele imagine in folderul “user“.

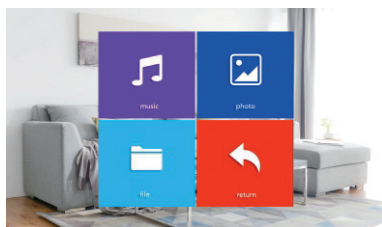

6. Record center

- **Video info** - contine inregistrarile video provenite de la unitatea externa.
- **Photo info** - contine capturile provenite de la unitatea externa.

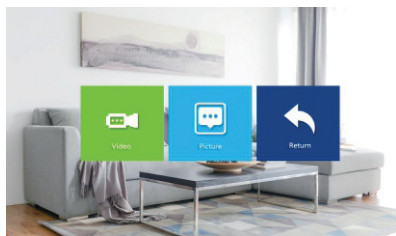

Specificatii tehnice

Sistem	Suporta 6 unitati de interior + 2 unitati de exterior + 2 camere CCTV
Semnal video de intrare	CVBS, CVI, TVI, AHD2.0
Monitor	7 inch
Rezolutie monitor	1024 x 600 px
Detectie miscare	Da
Mod apel	Intercom / Duplex
Capacitate maxima card micro SD	32GB, Clasa 10
Alimentare	230V (cu adaptorul de alimentare inclus) 12V (alimentare externa)
Consum	max. 600mA
Temperatura de lucru	-26°C ~ +60°C

EN:

EU Simplified Declaration of Conformity

SC ONLINESHOP SRL declares that **Smart video doorphone PNI SafeHome PT720MW** complies with the Directive EMC 2014/30/EU and RED 2014/53/UE. The full text of the EU declaration of conformity is available at the following Internet address:

<https://www.mypni.eu/products/7291/download/certifications>

RO:

Declaratie UE de conformitate simplificata

SC ONLINESHOP SRL declara ca **Interfon video inteligent PNI SafeHome PT720MW** este in conformitate cu Directiva EMC 2014/30/EU si RED 2014/53/UE. Textul integral al declaratiei UE de conformitate este disponibil la urmatoarea adresa de internet:

<https://www.mypni.eu/products/7291/download/certifications>