

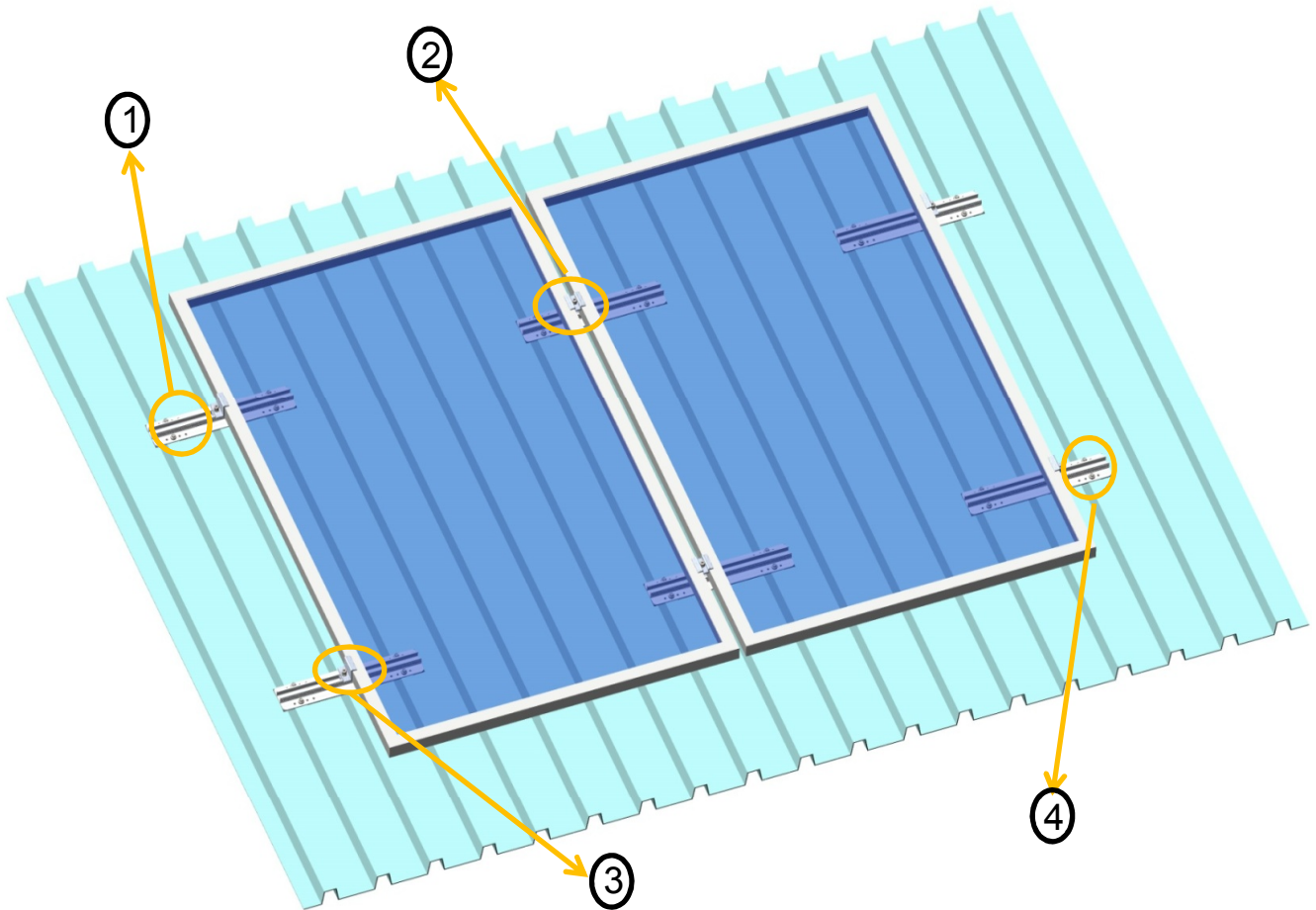



Installation Kit PNI Green Gouse S02 for 2 solar panels for metal sheet roof

Installation Manual



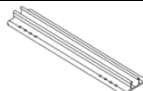

Overview



Components:

6 pcs	Mini Rail with EPDM sealing tape	
2 pcs	Mid Clamp	
4 pcs	End Clamp	
24 pcs	Cut Thread Self Tapping Screw	

TOOLS OVERVIEW

			
Cordless screwdriver	Torque wrench	Chalk line	Tape Measure

PNI S02 MINI RAIL SYSTEM ASSEMBLY

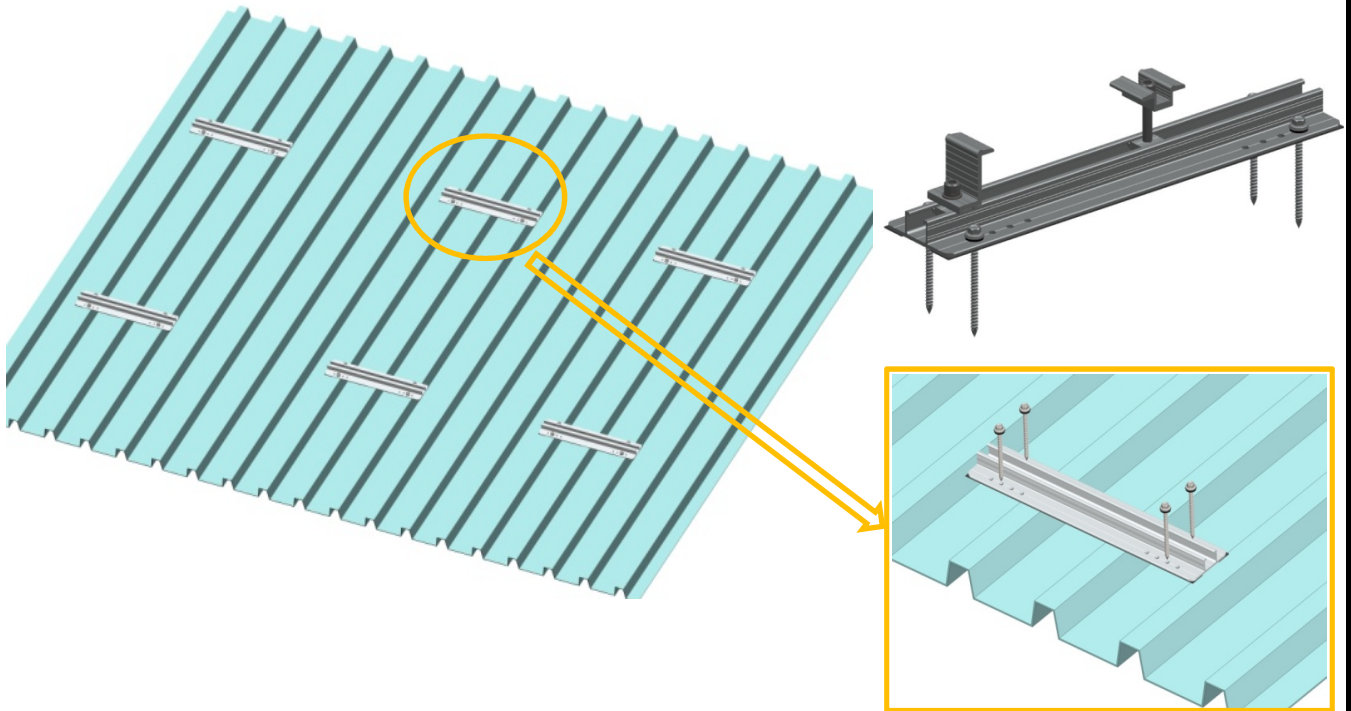

1.MEASURE AND FASTEN ALL MINI RAILS

Fasten Mini Rails with self-tapping screws on the roof.

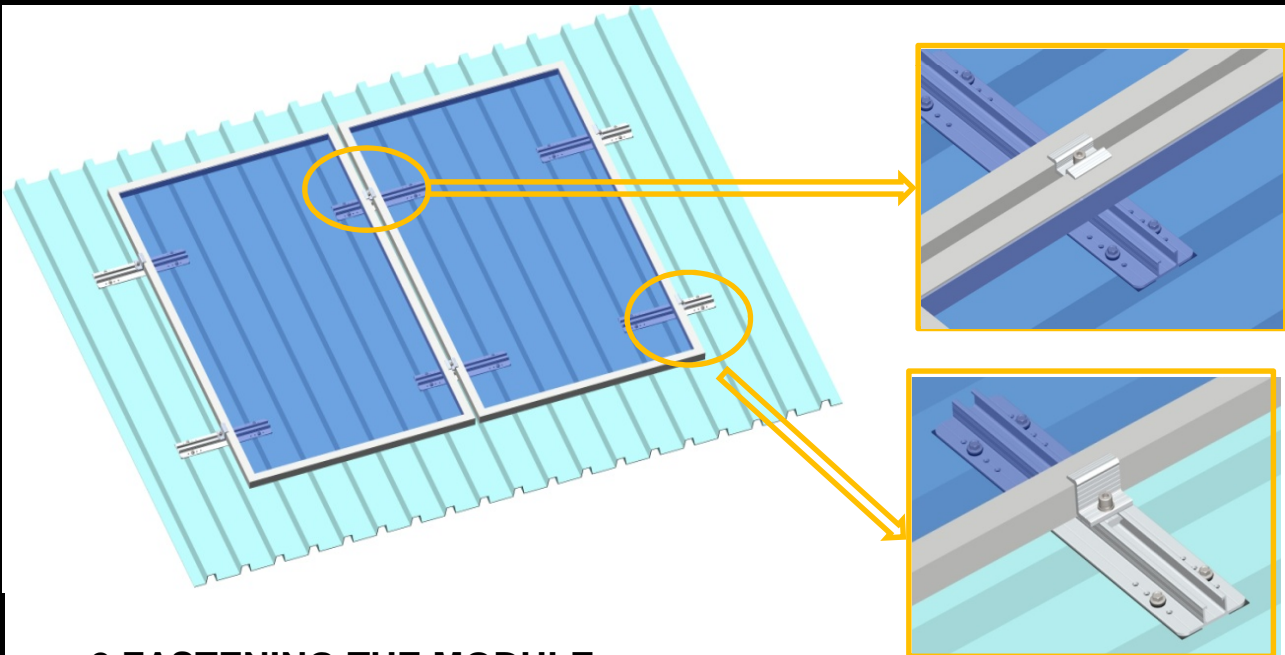

2.FASTENING THE MODULE

A. Insert Mid Clamp & End Clamp in the Mini Rail

B.Attached the Solar Modules to the Mini Rail

C. Fasten Mid/End Clamps,then installation finished



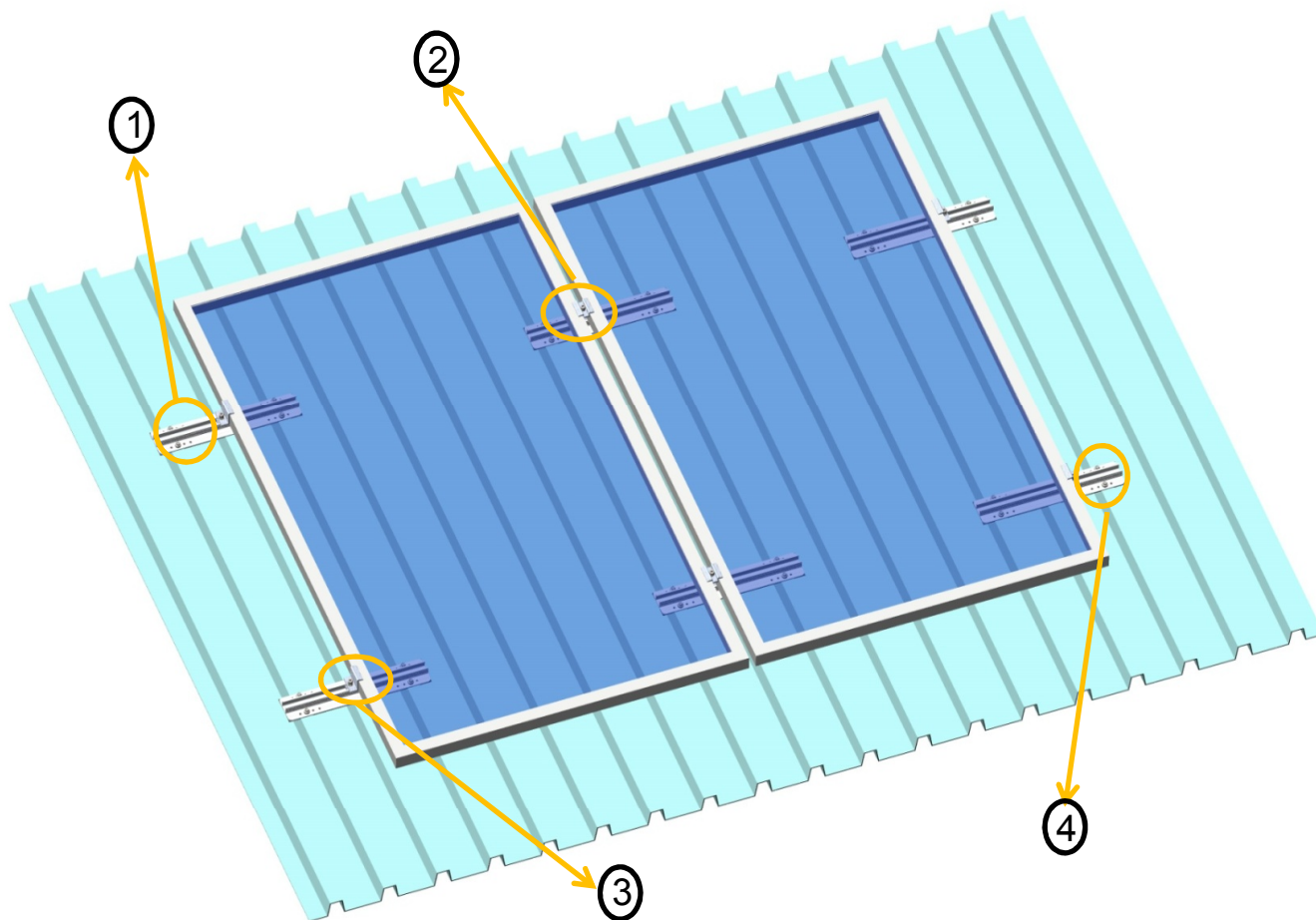

Kit de montaj PNI Green House S02 pentru panouri fotovoltaice pe acoperiș de tablă

Manual de utilizare

Prezentare generală

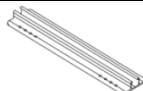

Componente:

6 bc	Mini profil de Al cu garnitură EPDM	
2 bc	Clemă de mijloc	
4 bc	Clemă de capăt	
24 bc	Șurub auto filetant	

nelte necesare pentru montaj

 Mașină de înșurubat cu acumulator	 Cheie cu clicket	 Fir aliniere	 Ruletă
--	---	---	---

Instalare kit montaj PNI Green House

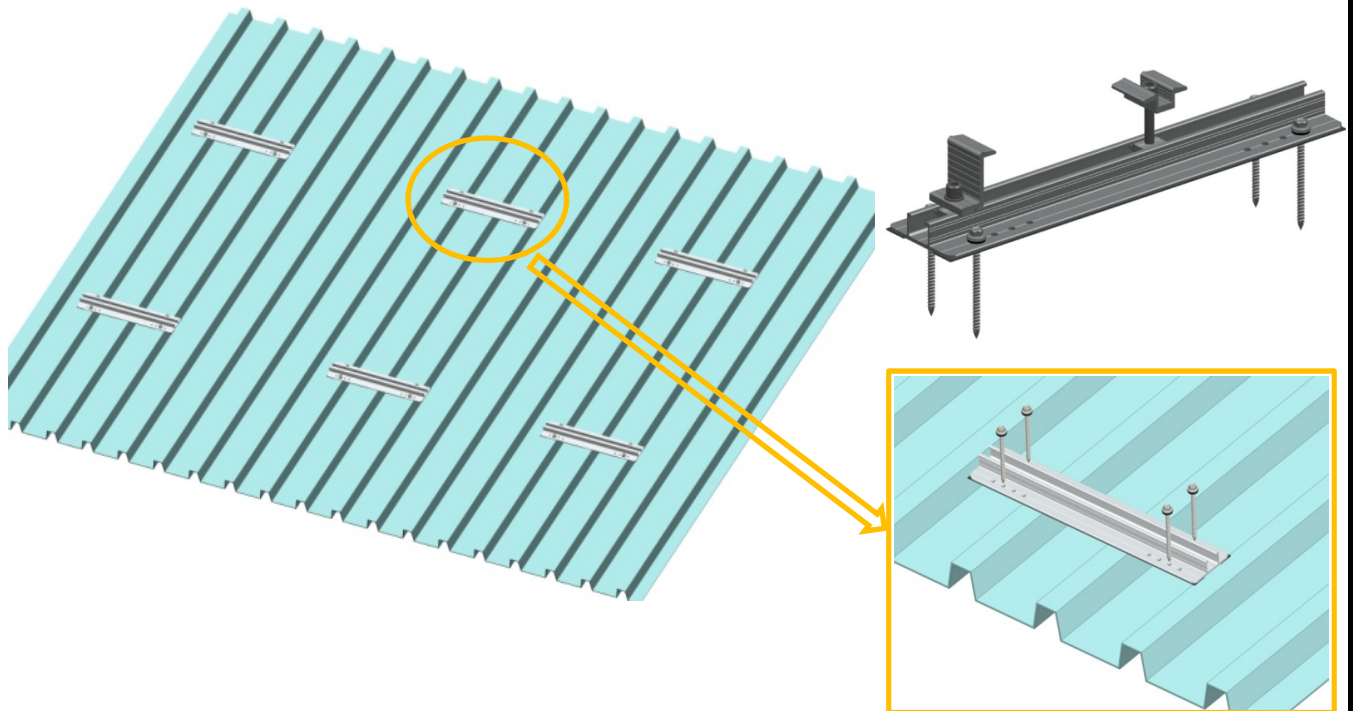

1. Măsurăți și fixați pe poziție profilele de aluminiu

Fixați pe acoperiș mini profilele cu ajutorul șuruburilor auto filetante

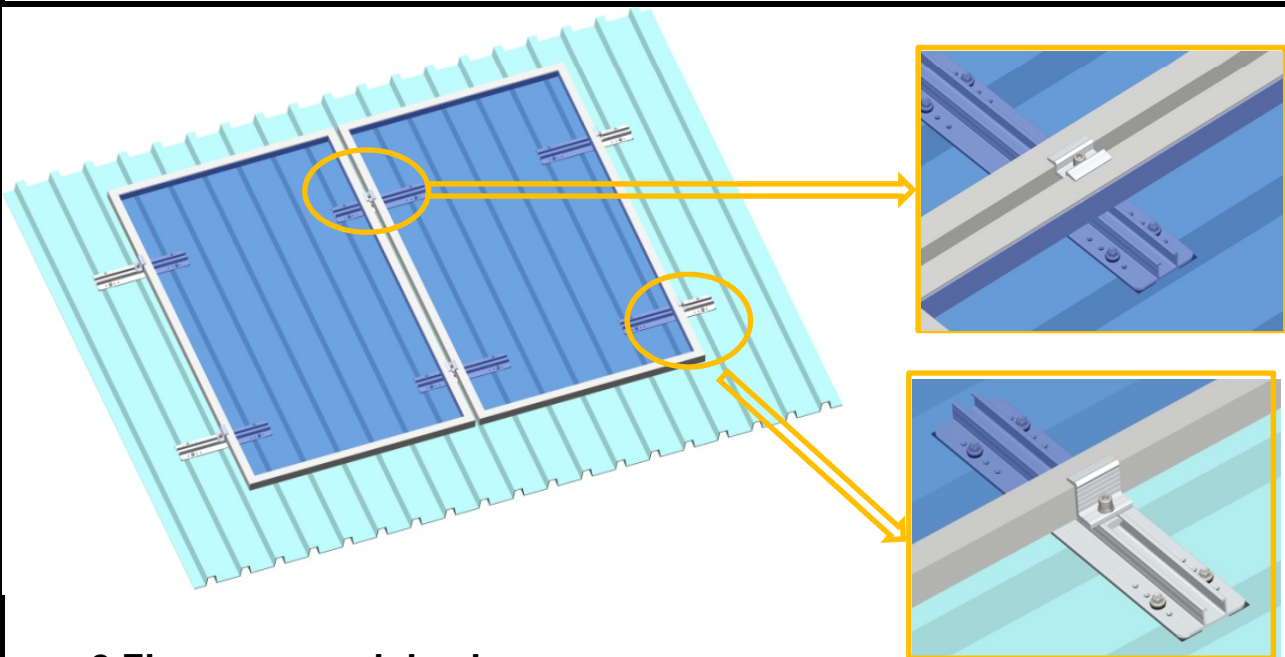

2. Fixarea panoului solar

A. Introduceți clema de mijloc și de capăt pe canalul mini profilului

B. Așezați panoul solar pe poziție pe profile între clemele de mijloc/capăt

C. Fixați clemele pe marginile panoului și strângeți șuruburile cu cheia