

PNI IP515J POE

POE Video
Surveillance Camera



- » POE камера за видеонаблюдение
- » POE-Videoüberwachungskamera
- » Câmera de videovigilância POE
- » Caméra de vidéosurveillance POE
- » POE videó megfigyelő kamera
- » Telecamera di videosorveglianza POE
- » POE-videobewakingscamera
- » Kamera do monitoringu wideo POE
- » Camera supraveghere video POE



Contents

English	3
Български	8
Deutsch	13
Español	18
Français	23
Magyar	28
Italiano	33
Nederlands	38
Polski	43
Romana	48

Safety warnings

- Before using the camera, read the user manual carefully.
- In case of malfunction, do not open the camera case and do not try to repair the camera yourself. Call a specialized service center.

Connection examples

Direct connection in NVR POE:

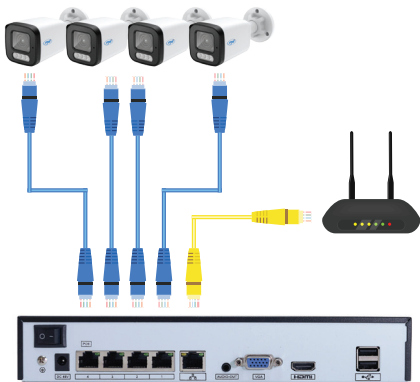

Connection via POE switch:

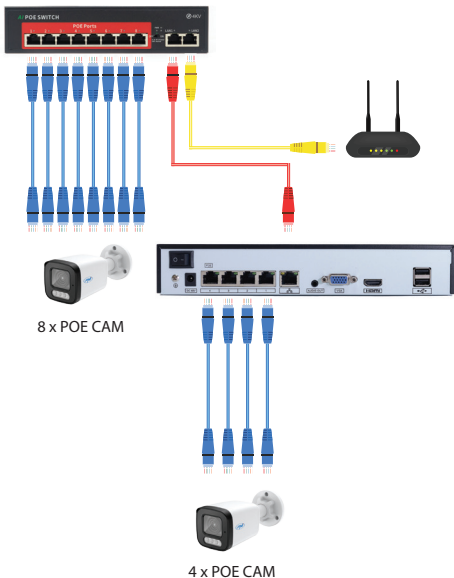

Note: In the diagram above, the NVR must support the connection of 12 IP cameras.

Technical specifications

Sensor	1/3" CMOS
Sensor resolution	5MP
Video resolution	2560 x 1920 px
Minimum illumination	Color:0.0001Lux (@ (F1.2,AGC ON); 0 Lux with IR B/W:0.0001 Lux (@ (F1.2,AGC ON); 0 Lux with IR
Lens	2.8 mm
IR Cut filter	Yes
AI functions	Face detection, human shape detection, vehicle shape detection, motion detection, image loss or image lock detection
Network protocol	TCP/IP, HTTP, DHCP, DNS, DDNS, PPPoE, SMTP, NTP, (HTTPS, SIP, 802.1x, IPv6

Video compression	H.265AI (compatible H.265/H.264 HighProfile)
Audio encoding	G.711a
Power supply	POE
Night vision	4 LEDs (2 IR LEDs + 2 white light LEDs)
IR distance	Up to 20-30 meters
Consumption	Max. 4W
Housing	Metal
Protection grade	IP67
Dimensions	68 x 38 x 174 mm
Ethernet interface	1* RJ45 10/100Mbps
Two-way audio	Yes, built-in microphone and speaker

Recommended compatible products:

POE NVR:

- NVR POE PNI House IP710J, 4 POE channels
- NVR POE PNI House IP716J, 8 POE channels
- NVR POE PNI House IP810, 4 POE channels

POE switch:

- Switch POE PNI SWPOE42, 4 POE ports
- Switch POE PNI SWPOE82, 8 POE ports
- Switch POE PNI SWPOE162, 16 POE ports

Simplified EU declaration of conformity

ONLINESHOP SRL declares that the **PNI IP515J POE video surveillance camera** complies with the EMC Directive 2014/30/EU. The full text of the EU declaration of conformity is available at the following internet address:

<https://www.mypni.eu/products/9956/download/certifications>

Предупреждения за безопасност

- Преди да използвате камерата, прочетете внимателно ръководството за потребителя.
- В случай на неизправност, не отваряйте кутията на камерата и не се опитвайте да поправите камерата сами. Обадете се в специализиран сервиз.

Примери за свързване

Директна връзка в NVR POE:

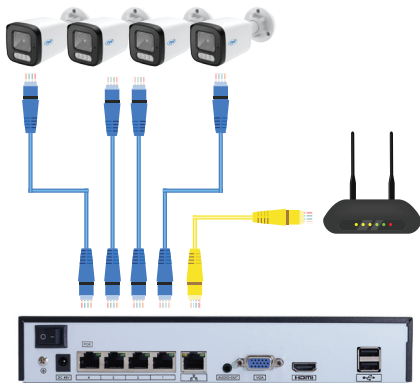

Връзка чрез POE комутатор:

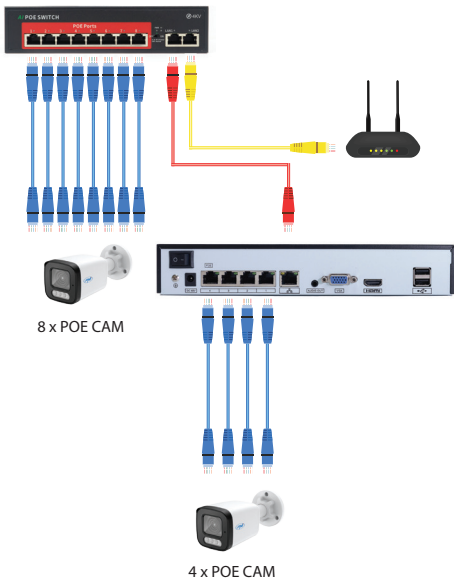

Note: In the diagram above, the NVR must support the connection of 12 IP cameras.

Технически спецификации

Сензор	1/3" CMOS
Разделителна способност на сензора	5MP
Видео резолюция	2560 x 1920 px
Минимално осветление	Цвят:0.0001Lux @ (F1.2,AGC ON); 0 Lux с IR Ч/Б: 0,0001 Lux @ (F1.2, AGC ВКЛ.); 0 Lux с IR
Лещи	2.8 mm
IR Cut филтър	да
AI функции	Разпознаване на лице, разпознаване на човешка форма, разпознаване на форма на превозно средство, разпознаване на движение, загуба на изображение или разпознаване на заключване на изображение

Мрежов протокол	TCP/IP, HTTP, DHCP, DNS, DDNS, PPPoE, SMTP, NTP, (HTTPS, SIP, 802.1x, IPv6)
Видео компресия	H.265AI (съвместим H.265/H.264 HighProfile)
Аудио кодиране	G.711a
Захранване	POE
Нощно виждане	4 светодиода (2 инфрачервени светодиода + 2 светодиода с бяла светлина)
IR разстояние	До 20-30 метра
Консумация	Макс. 4W
Жилища	Метал
Степен на защита	IP67
Размери	68 x 38 x 174 мм
Ethernet интерфейс	1* RJ45 10/100Mbps
Двупосочно аудио	Да, вграден микрофон и високоговорител

Препоръчани съвместими продукти:

POE NVR:

- NVR POE PNI House IP710J, 4 POE канала
- NVR POE PNI House IP716J, 8 POE канала
- NVR POE PNI House IP810, 4 POE канала

POE switch:

- Switch POE PNI SWPOE42, 4 POE порта
- Switch POE PNI SWPOE82, 8 POE порта
- Switch POE PNI SWPOE162, 16 POE порта

Опростена ЕС декларация за съответствие

ONLINESHOP SRL декларира, че камерата за видеонаблюдение PNI IP515J POE отговаря на EMC Директива 2014/30/EU. Пълният текст на ЕС декларацията за съответствие е достъпен на следния интернет адрес:

<https://www.mypni.eu/products/9956/download/certifications>

Sicherheitswarnungen

- Lesen Sie die Bedienungsanleitung sorgfältig durch, bevor Sie die Kamera verwenden.
- Öffnen Sie im Falle einer Fehlfunktion nicht das Kameragehäuse und versuchen Sie nicht, die Kamera selbst zu reparieren. Rufen Sie ein spezialisiertes Servicecenter an.

Anschlussbeispiele

Direkte Verbindung im NVR POE:

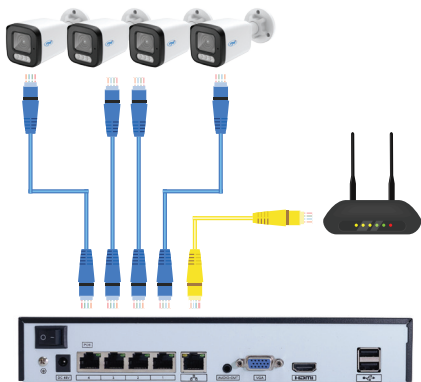

Verbindung über POE-Switch:

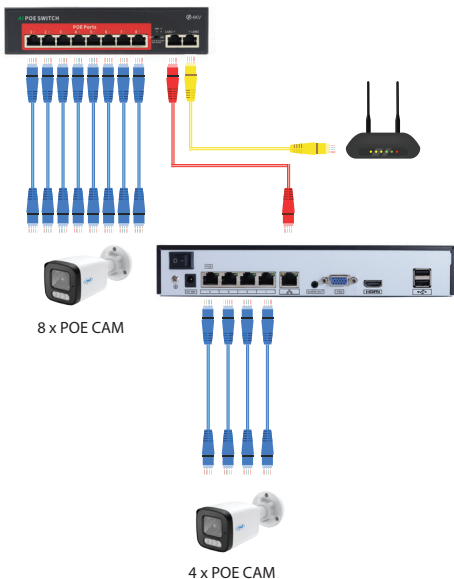

Hinweis: Im obigen Diagramm muss der NVR den Anschluss von 12 IP-Kameras unterstützen.

Technische Spezifikationen

Sensor	1/3" CMOS
Sensorauflösung	5MP
Video Auflösung	2560 x 1920 px
Minimale Beleuchtung	Farbe: 0,0001 Lux bei (F1,2, AGC EIN); 0 Lux mit IR S/W: 0,0001 Lux bei (F1,2, AGC EIN); 0 Lux mit IR
Linse	2.8 mm
IR Cut	Ja
KI-Funktionen	Gesichtserkennung, Erkennung menschlicher Formen, Erkennung von Fahrzeugformen, Bewegungserkennung, Erkennung von Bildverlust oder Bildsperre
Netzwerkprotokoll	TCP/IP, HTTP, DHCP, DNS, DDNS, PPPoE, SMTP, NTP, (HTTPS, SIP, 802.1x, IPv6

Video-Kompression	H.265AI (kompatibel H.265/H.264 HighProfile)
Audiokodierung	G.711a
Stromversorgung	POE
Nachtsicht	4 LEDs (2 IR-LEDs + 2 Weißlicht-LEDs)
IR-Entfernung	Bis zu 20-30 Meter
Verbrauch	Max. 4W
Gehäuse	Metall
Schutzgrad	IP67
Maße	68 x 38 x 174 mm
Ethernet-Schnittstelle	1* RJ45 10/100 Mbit/s
Zwei-Wege-Audio	Ja, eingebautes Mikrofon und Lautsprecher

Empfohlene kompatible Produkte:

POE NVR:

- NVR POE PNI House IP710J, 4 POE-Kanäle
- NVR POE PNI House IP716J, 8 POE-Kanäle
- NVR POE PNI House IP810, 4 POE-Kanäle

POE switch:

- Switch POE PNI SWPOE42, 4 POE-Ports
- Switch POE PNI SWPOE82, 8 POE-Ports
- Switch POE PNI SWPOE162, 16 POE-Ports

Vereinfachte EU-Konformitätserklärung

ONLINESHOP SRL erklärt, dass die POE-Videüberwachungskamera PNI IP515J der EMV-Richtlinie 2014/30/EU entspricht. Der vollständige Text der EU-Konformitätserklärung ist unter der folgenden Internetadresse verfügbar:

<https://www.mypni.eu/products/9956/download/certifications>

Advertencias de seguridad

- Antes de utilizar la cámara, lea atentamente el manual del usuario.
- En caso de mal funcionamiento, no abra la carcasa de la cámara ni intente repararla usted mismo. Llame a un centro de servicio especializado.

Ejemplos de conexión

Conexión directa en NVR POE:

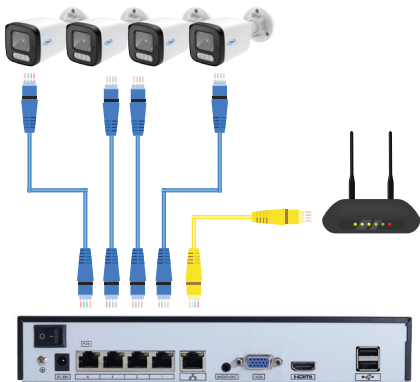

Conexión mediante conmutador POE:

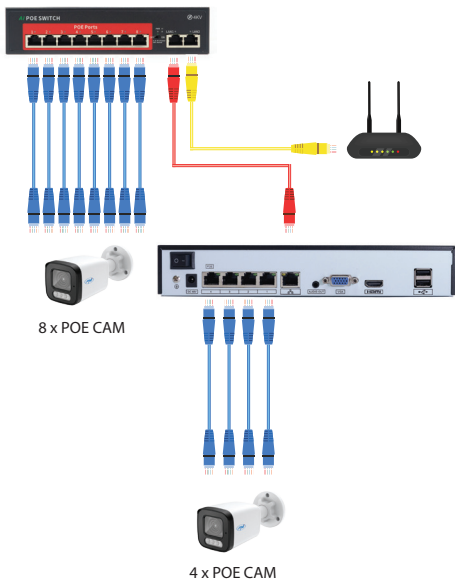

8 x POE CAM

4 x POE CAM

Nota: En el diagrama anterior, el NVR debe admitir la conexión de 12 cámaras IP.

Especificaciones técnicas

Sensor	1/3" CMOS
Resolución del sensor	5MP
Resolución de video	2560 x 1920 px
Iluminación mínima	Color:0.0001Lux (@ (F1.2,AGC ON); 0 Lux with IR B/W:0.0001 Lux (@ (F1.2,AGC ON); 0 Lux with IR
Lente	2.8 mm
IR Cut	Sí
Funciones de IA	Detección de rostros, detección de forma humana, detección de forma de vehículo, detección de movimiento, pérdida de imagen o detección de bloqueo de imagen

Protocolo de red	TCP/IP, HTTP, DHCP, DNS, DDNS, PPPoE, SMTP, NTP, (HTTPS, SIP, 802.1x, IPv6
Compresión de video	H.265A1 (compatible H.265/H.264 HighProfile
Codificación de audio	G.711a
Fuente de alimentación	POE
Vision nocturna	4 LED (2 LED IR + 2 LED de luz blanca)
Distancia infrarroja	Hasta 20-30 metros
Consumo	Máx. 4W
Alojamiento	Metal
Grado de protección	IP67
Dimensiones	68x38x174mm
Interfaz ethernet	1*RJ45 10/100 Mbps
Audio bidireccional	Sí, micrófono y altavoz integrados

Productos compatibles recomendados:

POE NVR:

- NVR POE PNI Casa IP710J, 4 canales POE
- NVR POE PNI Casa IP716J, 8 canales POE
- NVR POE PNI Casa IP810, 4 canales POE

POE switch:

- Switch POE PNI SWPOE42, 4 puertos POE
- Switch POE PNI SWPOE82, 8 puertos POE
- Switch POE PNI SWPOE162, 16 puertos POE

Declaración UE de conformidad simplificada

ONLINESHOP SRL declara que la cámara de videovigilancia PNI IP515J POE cumple con la Directiva EMC 2014/30/UE. El texto completo de la declaración UE de conformidad está disponible en la siguiente dirección de Internet:

<https://www.mypni.eu/products/9956/download/certifications>

Avertissements de sécurité

- Avant d'utiliser l'appareil photo, lisez attentivement le manuel d'utilisation.
- En cas de dysfonctionnement, n'ouvrez pas le boîtier de l'appareil photo et n'essayez pas de réparer l'appareil photo vous-même. Appeler un centre de service spécialisé.

Exemples de connexion

Connexion directe dans NVR POE:

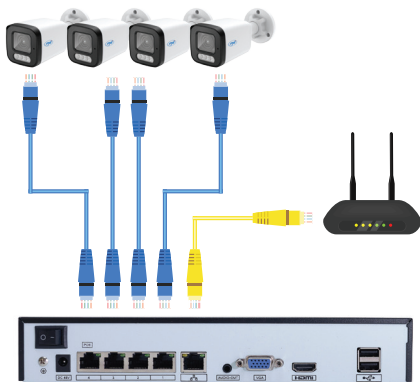

Connexion via commutateur POE:

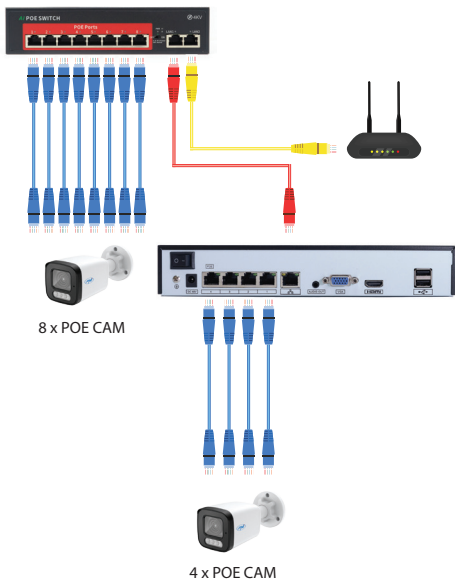

Remarque : Dans le schéma ci-dessus, le NVR doit prendre en charge la connexion de 12 caméras IP.

Spécifications techniques

Capteur	1/3" CMOS
Résolution du capteur	5MP
Résolution vidéo	2560 x 1920 px
Éclairage minimum	Couleur : 0,0001 Lux @ (F1.2, AGC activé) ; 0 Lux avec IR N/B : 0,0001 Lux @ (F1.2, AGC activé) ; 0 Lux avec IR
Lentille	2.8 mm
Filtre IR Cut	Oui
Fonctions IA	Détection de visage, détection de forme humaine, détection de forme de véhicule, détection de mouvement, détection de perte d'image ou détection de verrouillage d'image
Protocole réseau	TCP/IP, HTTP, DHCP, DNS, DDNS, PPPoE, SMTP, NTP, (HTTPS, SIP, 802.1x, IPv6

Compression de vidéo	H.265AI (compatible H.265/H.264 HighProfile)
Encodage audio	G.711a
Source de courant	POE
Vision nocturne	4 LED (2 LED IR + 2 LED lumière blanche)
Distance infrarouge	Jusqu'à 20-30 mètres
Consommation	Max. 4W
Logement	Métal
Degré de protection	IP67
Dimensions	68x38x174mm
Interface Ethernet	1*RJ45 10/100Mbps
Audio bidirectionnel	Oui, microphone et haut-parleur intégrés

Produits compatibles recommandés:

POE NVR:

- NVR POE PNI Maison IP710J, 4 canaux POE
- NVR POE PNI Maison IP716J, 8 canaux POE
- NVR POE PNI Maison IP810, 4 canaux POE

POE switch:

- Commutateur POE PNI SWPOE42, 4 ports POE
- Commutateur POE PNI SWPOE82, 8 ports POE
- Commutateur POE PNI SWPOE162, 16 ports POE

Déclaration de conformité UE simplifiée

ONLINESHOP SRL déclare que la caméra de vidéosurveillance PNI IP515J POE est conforme à la directive EMC 2014/30/UE. Le texte intégral de la déclaration UE de conformité est disponible à l'adresse Internet suivante:

<https://www.mypni.eu/products/9956/download/certifications>

Biztonsági figyelmeztetések

- A fényképezőgép használata előtt figyelmesen olvassa el a használati útmutatót.
- Meghibásodás esetén ne nyissa ki a fényképezőgép házat, és ne próbálja meg saját maga megjavítani a fényképezőgépet. Hívjon egy speciális szervizközpontot.

Csatlakozási példák

Közvetlen kapcsolat az NVR POE-ben:

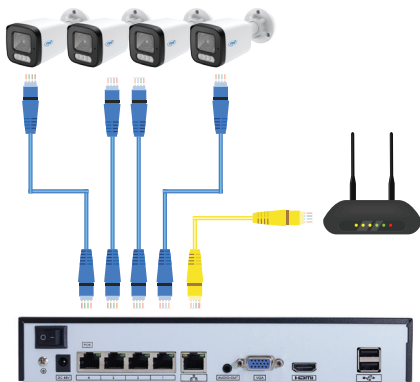

Csatlakozás POE kapcsolón keresztül:

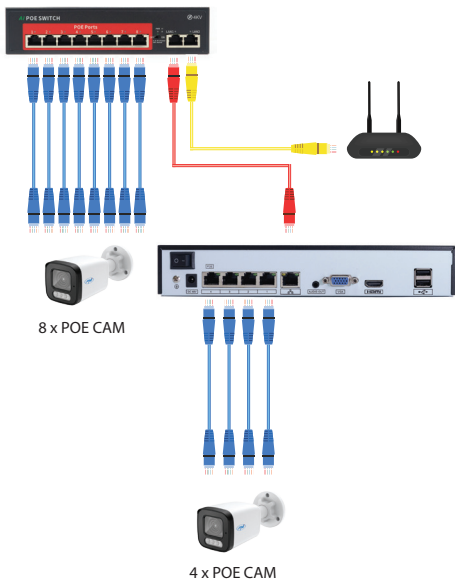

Megjegyzés: A fenti ábrán az NVR-nek támogatnia kell 12 IP kamera csatlakoztatását.

Műszaki adatok

Érzékelő	1/3" CMOS
Szenzor felbontása	5MP
Videó felbontás	2560 x 1920 px
Minimális megvilágítás	Color:0.0001Lux (@ (F1.2,AGC ON); 0 Lux with IR B/W:0.0001 Lux (@ (F1.2,AGC ON); 0 Lux with IR
Lencse	2.8 mm
IR Cut	Igen
AI funkciók	Arcfelismerés, emberi alakérzékelés, jármű alakérzékelés, mozgásérzékelés, képvesztés vagy képzárás észlelése
Hálózati protokoll	TCP/IP, HTTP, DHCP, DNS, DDNS, PPPoE, SMTP, NTP, (HTTPS, SIP, 802.1x, IPv6

Videó tömörítés	H.265AI (compatible H.265/H.264 HighProfile)
Hangkódolás	G.711a
Tápegység	POE
Éjszakai látás	4 LED (2 IR LED + 2 fehér fényű LED)
IR távolság	20-30 méterig
Fogyasztás	Max. 4W
Ház	Fém
Védelmi fokozat	IP67
Méreték	68 x 38 x 174 mm
Ethernet interfész	1* RJ45 10/100Mbps
Kétirányú hang	Igen, beépített mikrofon és hangszóró

Ajánlott kompatibilis termékek:

POE NVR:

- NVR POE PNI House IP710J, 4 POE csatorna
- NVR POE PNI House IP716J, 8 POE csatorna
- NVR POE PNI House IP810, 4 POE csatorna

POE switch:

- Kapcsoló POE PNI SWPOE42, 4 POE port
- Kapcsoló POE PNI SWPOE82, 8 POE port
- Kapcsoló POE PNI SWPOE162, 16 POE port

Egyszerűsített EU megfelelőségi nyilatkozat

Az ONLINESHOP SRL kijelenti, hogy a PNI IP515J POE videó megfigyelő kamera megfelel a 2014/30/EU EMC-irányelvnek. Az EU-megfelelőségi nyilatkozat teljes szövege az alábbi internetcímen érhető el:

<https://www.mypni.eu/products/9956/download/certifications>

Avvertenze di sicurezza

- Prima di utilizzare la fotocamera, leggere attentamente il manuale dell'utente.
- In caso di malfunzionamento, non aprire la custodia della fotocamera e non tentare di riparare da soli la fotocamera. Chiamare un centro assistenza specializzato.

Esempi di connessione

Connessione diretta nell'NVR POE:

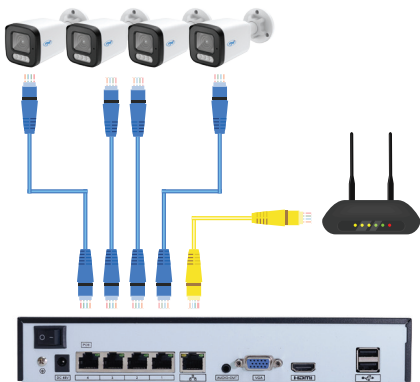

Collegamento tramite switch POE:

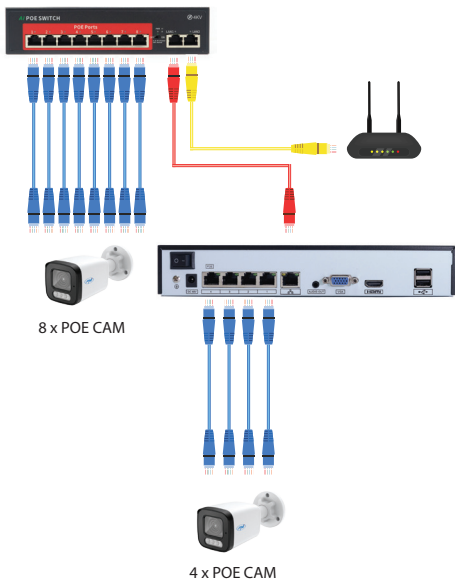

Nota: nello schema sopra, l’NVR deve supportare la connessione di 12 telecamere IP.

Specifiche tecniche

Sensore	1/3" CMOS
Risoluzione del sensore	5MP
Risoluzione video	2560 x 1920 px
Illuminazione minima	Colore: 0,0001 Lux @ (F1.2,AGC ATTIVO); 0 Lux con IR B/N: 0,0001 Lux @ (F1.2,AGC ATTIVO); 0 Lux con IR
Lente	2.8 mm
Filtro IR Cut	Sì
Funzioni dell'intelligenza artificiale	Rilevamento del volto, rilevamento della forma umana, rilevamento della forma del veicolo, rilevamento del movimento, rilevamento della perdita di immagine o rilevamento del blocco dell'immagine

Protocollo di rete	TCP/IP, HTTP, DHCP, DNS, DDNS, PPPoE, SMTP, NTP, (HTTPS, SIP, 802.1x, IPv6
Compressione video	H.265AI (compatible H.265/H.264 HighProfile
Codifica audio	G.711a
Alimentazione elettrica	POE
Visione notturna	4 LED (2 LED IR + 2 LED a luce bianca)
Distanza IR	Fino a 20-30 metri
Consumo	Massimo. 4 W
Alloggiamento	Metallo
Grado di protezione	IP67
Dimensioni	68×38×174 mm
Interfaccia Ethernet	1 * RJ45 10/100 Mbps
Audio bidirezionale	Sì, microfono e altoparlante integrati

Prodotti compatibili consigliati:

POE NVR:

- NVR POE PNI House IP710J, 4 canali POE
- NVR POE PNI House IP716J, 8 canali POE
- NVR POE PNI House IP810, 4 canali POE

POE switch:

- Switch POE PNI SWPOE42, 4 porte POE
- Switch POE PNI SWPOE82, 8 porte POE
- Switch POE PNI SWPOE162, 16 porte POE

Dichiarazione di conformità UE semplificata

ONLINESHOP SRL dichiara che la telecamera di videosorveglianza PNI IP515J POE è conforme alla Direttiva EMC 2014/30/UE. Il testo completo della dichiarazione di conformità UE è disponibile al seguente indirizzo internet:

<https://www.mypni.eu/products/9956/download/certifications>

Veiligheidswaarschuwingen

- Lees de gebruikershandleiding zorgvuldig door voordat u de camera gebruikt.
- Open in geval van een storing de camerabehuizing niet en probeer de camera niet zelf te repareren. Bel een gespecialiseerd servicecentrum.

Verbindingsvoorbeelden

Directe verbinding in NVR POE:

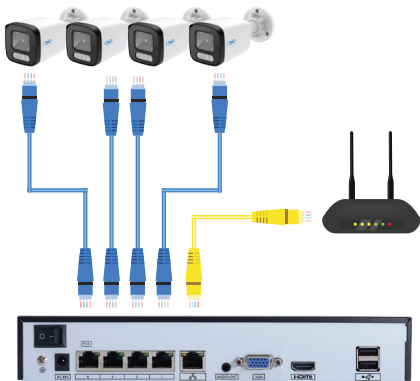

Aansluiting via POE-schakelaar:

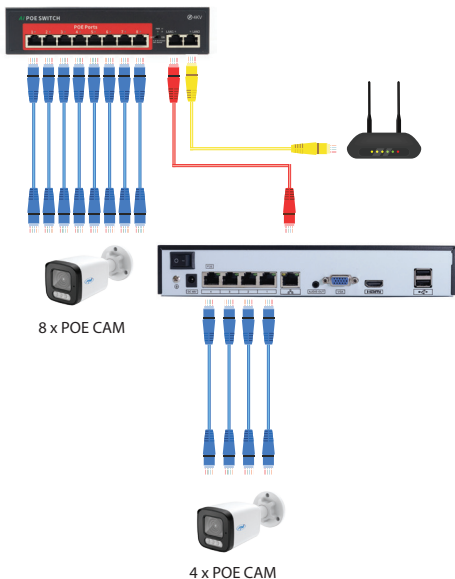

Let op: In het bovenstaande schema moet de NVR de aansluiting van 12 IP-camera's ondersteunen.

Technische specificaties

Sensor	1/3" CMOS
Sensorresolutie	5MP
Video resolutie	2560 x 1920 px
Minimale verlichting	Kleur: 0,0001Lux (@ (F1.2,AGC AAN); 0 lux met IR Z/W:0,0001 Lux (@ (F1.2,AGC AAN); 0 lux met IR
Lens	2.8 mm
IR Cut-filter	Ja
AI-functies	Gezichtsdetectie, menselijke vormdetectie, voertuigvorm detectie, bewegingsdetectie, beeldverlies of beeldvergrendelings detectie

Netwerkprotocol	TCP/IP, HTTP, DHCP, DNS, DDNS, PPPoE, SMTP, NTP, (HTTPS, SIP, 802.1x, IPv6
Video compressie	H.265AI (verenigbaar H.265/H.264 HighProfile
Audiocodering	G.711a
Stroomvoorziening	POE
Nachtzicht	4 LED's (2 IR-LED's + 2 witlicht-LED's)
IR-afstand	Tot 20-30 meter
Consumptie	Max. 4W
Huisvesting	Metaal
Beschermingsgraad	IP67
Dimensies	68 x 38 x 174 mm
Ethernet-interface	1* RJ45 10/100 Mbps
Tweerichtingsaudio	Ja, ingebouwde microfoon en luidspreker

Aanbevolen compatibele producten:

POE NVR:

- NVR POE PNI House IP710J, 4 POE kanalen
- NVR POE PNI House IP716J, 8 POE kanalen
- NVR POE PNI House IP810, 4 POE kanalen

POE switch:

- Switch POE PNI SWPOE42, 4 POE-poorten
- Switch POE PNI SWPOE82, 8 POE-poorten
- Switch POE PNI SWPOE162, 16 POE-poorten

Vereenvoudigde EU-conformiteitsverklaring

ONLINESHOP SRL verklaart dat de PNI IP515J POE videobewakingscamera voldoet aan de EMC-richtlijn 2014/30/EU. De volledige tekst van de EU-conformiteitsverklaring is beschikbaar op het volgende internetadres:

<https://www.mypni.eu/products/9956/download/certifications>

Ostrzeżenia dotyczące bezpieczeństwa

- Przed użyciem aparatu przeczytaj uważnie instrukcję obsługi.
- W przypadku awarii nie otwieraj obudowy aparatu i nie próbuj samodzielnie naprawiać aparatu. Zadzwoń do specjalistycznego centrum serwisowego.

Przykłady połączeń

Bezpośrednie połączenie w NVR POE:

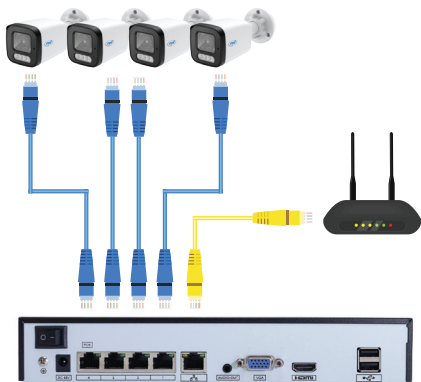

Połączenie za pomocą przełącznika POE:

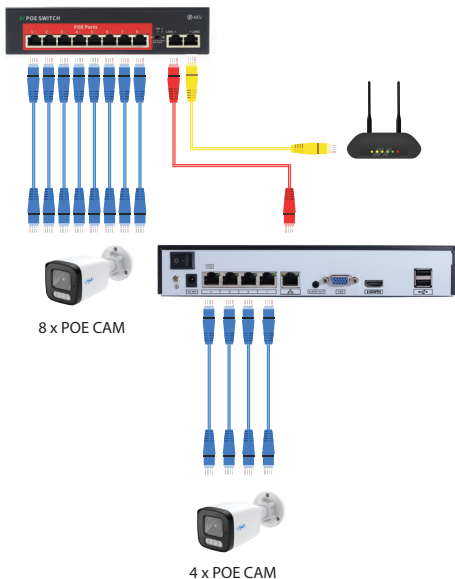

Uwaga: Na powyższym schemacie NVR musi obsługiwać połączenie 12 kamer IP.

Specyfikacja techniczna

Czujnik	1/3" CMOS
Rozdzielczość czujnika	5MP
Rozdzielczość wideo	2560 x 1920 px
Minimalne oświetlenie	Kolor: 0,0001 luksa @ (F1,2, AGC WŁ.); 0 luksów z podczerwienią Czarno-biały: 0,0001 luksa @ (F1.2, AGC WŁ.); 0 luksów z podczerwienią
Obiektyw	2.8 mm
Filtr podczerwieni	Tak
Funkcje sztucznej inteligencji	Wykrywanie twarzy, wykrywanie kształtu człowieka, wykrywanie kształtu pojazdu, wykrywanie ruchu, wykrywanie utraty obrazu lub wykrywania blokady obrazu

Protokół sieciowy	TCP/IP, HTTP, DHCP, DNS, DDNS, PPPoE, SMTP, NTP, (HTTPS, SIP, 802.1x, IPv6
Kompresja wideo	H.265A1 (zgodny H.265/H.264 HighProfile
Kodowanie dźwięku	G.711a
Zasilacz	POE
Nocna wizja	4 diody LED (2 diody podczerwieni + 2 diody LED światła białego)
Odległość podczerwieni	Do 20-30 metrów
Konsumpcja	Maks. 4W
Mieszkania	Metal
Stopień ochrony	IP67
Wymiary	68 x 38 x 174 mm
Interfejs Ethernet	1*RJ45 10/100Mbps
Dwukierunkowe audio	Tak, wbudowany mikrofon i głośnik

Polecane kompatybilne produkty:

POE NVR:

- NVR POE PNI House IP710J, 4 kanały POE
- NVR POE PNI House IP716J, 8 kanałów POE
- NVR POE PNI House IP810, 4 kanały POE

POE switch:

- Przełącznik POE PNI SWPOE42, 4 porty POE
- Przełącznik POE PNI SWPOE82, 8 portów POE
- Przełącznik POE PNI SWPOE162, 16 portów POE

Uproszczona deklaracja zgodności UE

ONLINESHOP SRL oświadcza, że kamera do monitoringu wideo PNI IP515J POE jest zgodna z dyrektywą EMC 2014/30/UE. Pełny tekst deklaracji zgodności UE dostępny jest pod następującym adresem internetowym:

<https://www.mypni.eu/products/9956/download/certifications>

Atentionari de siguranta

- Inainte de a folosi camera, cititi cu atentie manualul de utilizare.
- In caz de defectiune, nu desfaceti carcasa camerei si nu incercati sa reparati camera singur. Apelati la un centru service specializat.

Exemple de conexiune

Conexiune directa in NVR POE:

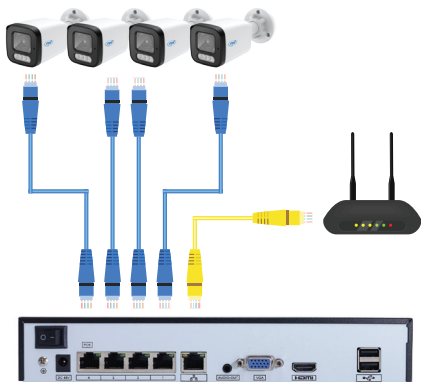

Conexiune prin switch POE:

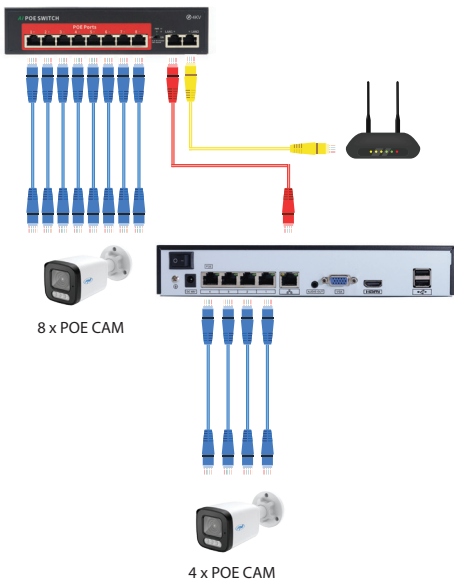

Nota: In schema de mai sus, NVR-ul trebuie sa suporte conectarea a 12 camere IP.

Specificatii tehnice

Senzor	1/3" CMOS
Rezolutie senzor	5MP
Rezolutie video	2560 x 1920 px
Iluminare minima	Color:0.0001Lux (@ (F1.2,AGC ON); 0 Lux with IR B/W:0.0001 Lux (@ (F1.2,AGC ON); 0 Lux with IR
Lentila	2.8 mm
Filtru IR Cut	Da
Functii AI	Detectie chip uman, detectie forma umana, detectie forma vehicul, detectie miscare, detectie pierdere imagine sau blocare imagine
Protocol retea	TCP/IP, HTTP, DHCP, DNS, DDNS, PPPoE, SMTP, NTP, (HTTPS, SIP, 802.1x, IPv6

Compresie video	H.265AI (compatibil H.265/H.264 HighProfile)
Codare audio	G.711a
Alimentare	POE
LED-uri	4 LED-uri (2 LED-uri IR + 2 LED-uri cu lumina alba)
Distanta IR	Pana la 20-30 metri
Consum	Max. 4W
Carcasa	Metal
Rezistentă la apă	IP67
Dimensiuni	68 x 38 x 174 mm
Interfata Ethernet	1* RJ45 10/100Mbps
Audio bidirectional	Da, microfon și difuzor încorporate

Produse compatibile recomandate:

NVR-uri POE:

- NVR POE PNI House IP710J, 4 canale POE
- NVR POE PNI House IP716J, 8 canale POE
- NVR POE PNI House IP810, 4 canale POE

Switch-uri POE:

- Switch POE PNI SWPOE42, 4 porturi POE
- Switch POE PNI SWPOE82, 8 porturi POE
- Switch POE PNI SWPOE162, 16 porturi POE

Declaratie UE de conformitate simplificata

ONLINESHOP SRL declara ca **Camera supraveghere video PNI IP515J POE** este in conformitate cu Directiva EMC 2014/30/EU. Textul integral al declaratiei UE de conformitate este disponibil la urmatoarea adresa de internet:

<https://www.mypni.eu/products/9956/download/certifications>

